



SEAT LCR TCR DSG
USER MANUAL
2017

INDEX

1	TECHNICAL INFORMATION.....	4
1.1	SEAT LCR TCR DSG display	4
1.2	Dimensions and weight	5
1.3	Bodywork.....	5
1.4	Engine.....	7
1.5	Fuel tank.....	7
1.6	Power transmission	8
1.7	Chassis	8
1.8	Electronic units	9
2	DRIVER CONTROLS	10
2.1	Main panel	10
2.2	Steering wheel module	10
2.3	Speed limiter (Pit limiter/Full Course Yellow/120 limiter).....	12
2.4	Display alarms and shift lights	12
2.5	Gearbox functioning.....	13
2.6	Standing start procedure	14
2.7	Rear brake pressure proportioning valve.....	15
2.8	Driver has to consider	15
3	ELECTRONICS.....	16
3.1	AIM MXG	16
3.2	MXG connection schemes.....	17
3.3	Data acquisition.....	18
3.4	Fusebox	19
3.5	Fuel level display	22
3.6	Auxiliary connectors	23
3.7	Fire extinguisher	25
4	SETTING ADJUSTMENTS.....	26
4.1	Standard set-up	26
4.2	Steering rack centring	27
4.3	Front camber and toe adjustments	27
4.4	Rear camber and toe adjustments	28
4.5	Suspension	29
4.6	Anti-roll bars.....	31

4.7	Kinematics.....	32
4.8	Brakes.....	34
4.9	Aerodynamics	35
4.10	Driving position	35
5	WORKSHOP MAINTENANCE	38
5.1	First roll-out.....	38
5.2	Check-list.....	38
5.3	Body-shell and engine identification.....	39
5.4	Fluids	40
5.5	Engine.....	40
5.6	Air filter.....	40
5.7	DSG gearbox	41
5.8	VAQ differential.....	42
5.9	Fuel tank.....	43
5.10	Airjacks.....	46
6	PARTS MILEAGE	48

1 TECHNICAL INFORMATION

1.1 SEAT LCR TCR DSG display

Engine

\ Type	Four-cylinder in line 2.0 TSI
\ Layout	Transversally mounted in front axle
\ Capacity	1984 cc
\ Bore / stroke	82.5 mm / 92.8 mm
\ Output	257 kW (350 hp) / 6250 rpm
\ Torque	420 Nm / 2500 to 5500 rpm
\ ECU	Continental SIMOS
\ Exhaust	Twin-end racing catalyst

Power transmission

\ Transmission	Front-wheel drive
\ Gearbox	Direct-shift gearbox (DSG)
\ Differential	VAQ electro-hydraulic
\ Clutch	Standard double clutch
\ Shift control	Paddle-shift on steering wheel

Chassis

\ Front suspension	McPherson, adjustable in height, toe and camber
\ Anti-roll bar	Front and rear adjustable in 6 positions
\ Rear suspension	Multi-link adjustable in height, toe and camber
\ Front brakes	6-piston callipers, \varnothing 378x34 mm ventilated discs
\ Rear brakes	\varnothing 272x10 mm solid discs
\ Brake pedal	With brake balance regulation
\ Hand brake	Hydraulic with mechanical locking
\ Steering system	Electrical power steering rack
\ Rims	SEAT Sport 10x18 inch
\ ABS	Optional

Body

\ Roll-cage	Welded steel FIA homologated
\ Weight	1.190 kg
\ Front width (max)	1.950 mm
\ Rear width (max)	1.950 mm
\ Length	4.547 mm
\ Wheel base	2.665 mm

Equipment and safety

\ Acquisition system	AIM - MXG 60 channels
\ Car check control	Auto-diagnosis OBDII / DiagRA – LE
\ Speed limiter (VSC)	5 variable speeds
\ Launch control	Available
\ Airjack system	3 airjacks
\ Fire extinguisher	OMP
\ Seat	OMP
\ Fuel tank	FIA FT3 Fuel Tank

1.2 Dimensions and weight

Dimensions	Measurements	Remarks
Overall length	4547 mm	
Overall bodywork front width	1950 mm	
Overall bodywork rear width	1950 mm	
Wheel base	2665 mm	
Over hang front splitter	897 mm	
Over hang front bumper	867 mm	
Over hang rear	825 mm	
Over hang rear wing*	160 mm	From the wing to the bumper
Minimum ground clearance	-	80 mm according to TCR regulations

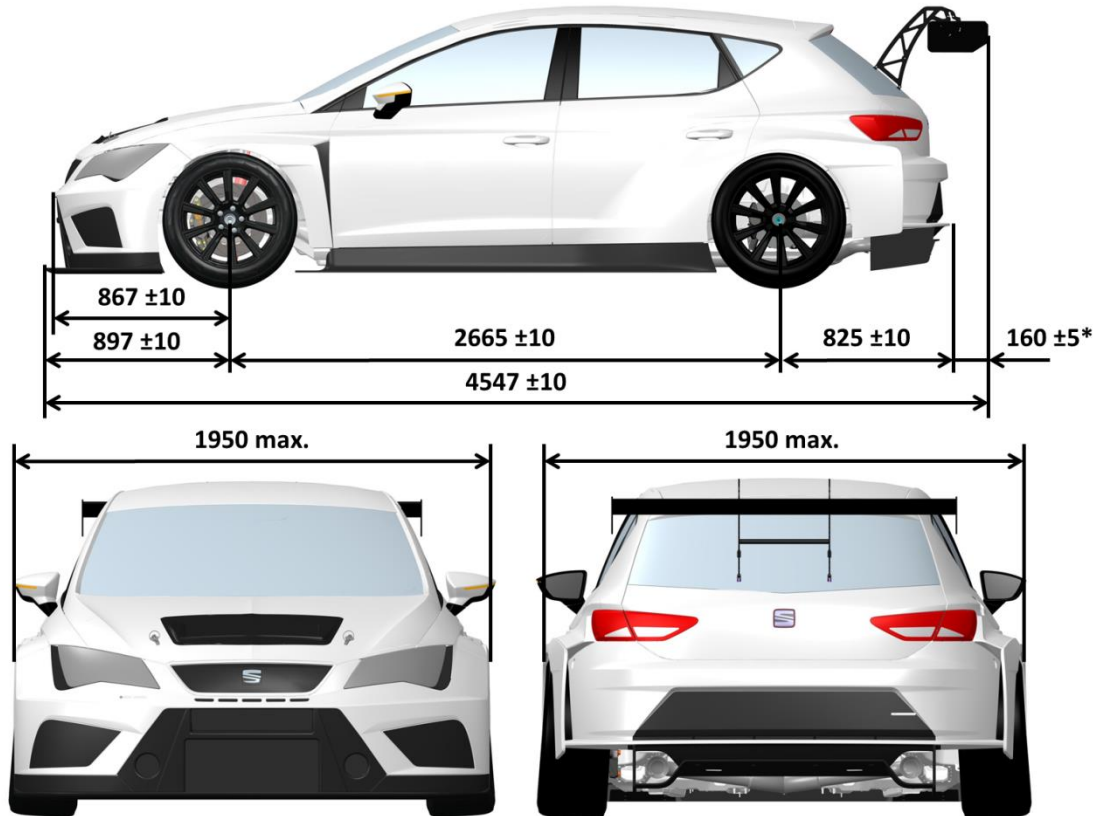

Weight	Measurements
Total weight in race conditions without fuel	1190 kg **
Car balance	61% front / 39% rear
Distribution weight/power	3,4 kg/hp

Notes:

* Measured from the rear bumper to the end of rear wing profile.

** The scrutineering dimensions and minimum weight are the ones on the SEAT LCR TCR V3 DSG Technical Form.

1.3 Bodywork

Part number	Description	Material
01	Bonnet	Steel
02	Left / right front door	Steel
03	Left / right rear door	Steel
04	Roof	Steel
05	Boot lid	Steel
10	Bumper air duct	Plastic

11	Bonnet opening	Carbon
12	Front splitter	Carbon
13	Fender air exit	Carbon
14	Front bumper	Fiberglass
15	Rear bumper	Fiberglass
16	Left / right side trim	Carbon, Kevlar & Fiberglass
17	Left / right rear door extension	Carbon (painted)
18	Left / right rear fender extension	Carbon (painted)
19	Left / right front fender	Carbon (painted)
20	Diffuser	Carbon
21	Windscreen	Glass
22	Left / right front door window	Glass
23	Left / right rear door window	Glass
24	Left / right rear triangle window	Plastic
25	Rear window	Plastic

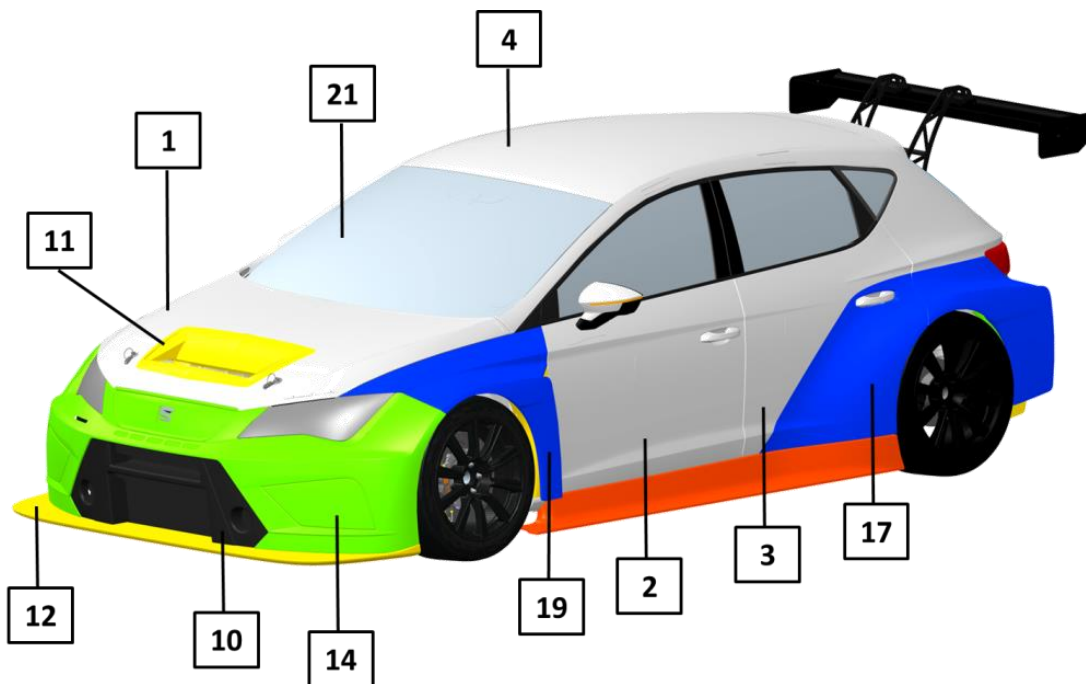
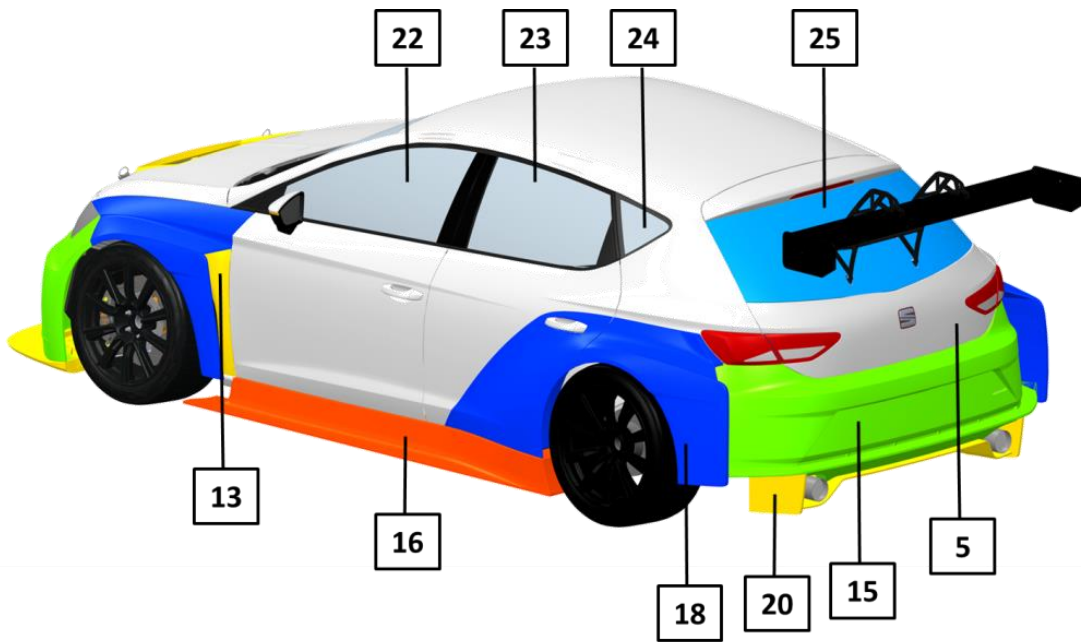

1.4 Engine

Engine features	Description
Type	2,0 TSI / Turbocharged and direct fuel injection
Engine identification	CJX
Cylinder capacity	1984 cc
Corrected cylinder capacity	1984x1,7 = 3372,8 cc
Maximum power	257 kW (350 hp) at 6250 rpm
Maximum torque	420 Nm / from 2500 to 5500 rpm
Maximum rpm	6800 rpm
Specific power	175 hp/l
Electronic control unit	CONTINENTAL SIMOS 18.1
Fuel	RON MIN 98 / RON MAX 102
Fuel consumption	0,37 to 0,42 l/km
Exhaust	Twin-end racing catalyst FIA Homologated
Distribution	Chain (sealed)
Oil system	Wet sump
Water pump	Mechanical water pump + one auxiliary electrical pump
Water thermostat	Electromechanical
Fan range	Operating range 92°C to 87°C

Engine power and torque curve:

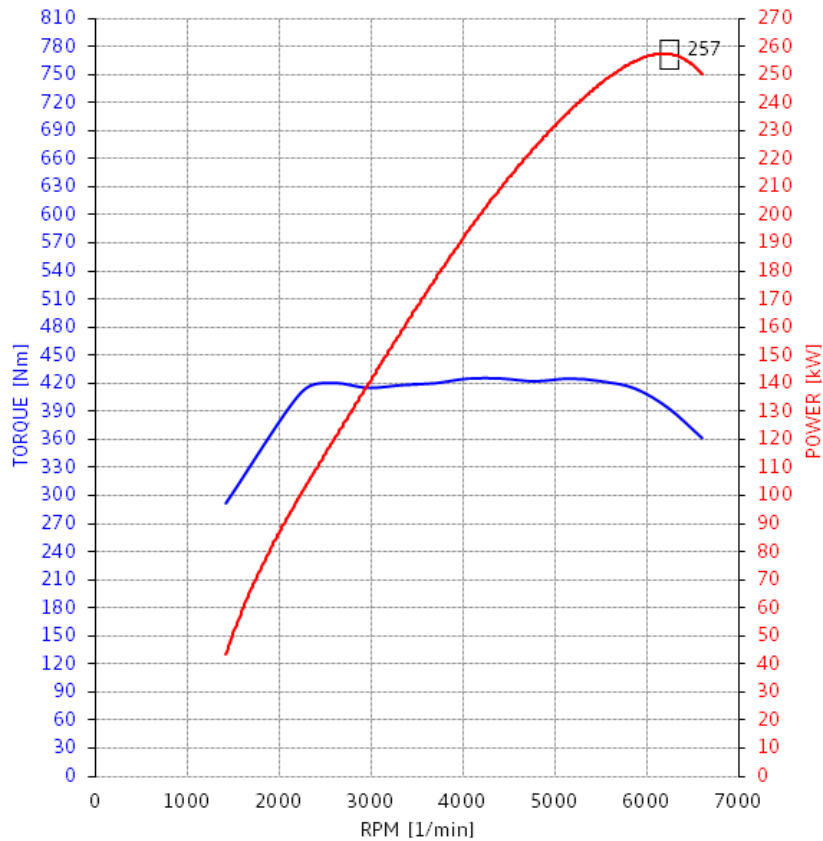

1.5 Fuel tank

Fuel tank features	Description
Fuel tank type	FIA FT3 homologated fuel tank
Capacity	100 l ±2%
Minimum fuel level before engine fault	Less than 1 litre
Ventilation valve	FIA homologated roll-over, ventilation and 200 mbar pressure regulator valve
Refuelling	Safety FIA plug

1.6 Power transmission

Power transmission features	Description
Transmission	Front-wheel drive
Clutch	Standard double clutch
Gearbox	Direct-shift gearbox (DSG)
Gearbox mode control	Electronic lever on main console
Gearbox shift control	Paddle-shift on steering wheel
Gearbox control unit	Mechatronic in oil bath
Gearbox cooling system	Oil-water exchanger
Downshift over-rev protection	Electronically activated with memory function
Differential	VAQ electro-hydraulic with 3 modes available
Differential mode control	Dedicated button on steering wheel

Gear ratios								
GEAR	Z1	Z2	Gear relation	Total relation	RPM 3000	GEAR SHIFT 6500	CUT 6800	DIFF RPM
1	13	38	0,342	0,071	26	56	58	
2	22	45	0,489	0,102	37	80	83	1952
3	28	41	0,683	0,142	51	111	117	1847
4	38	41	0,927	0,193	70	151	158	1711
5	32	35	0,914	0,254	92	199	208	1558
6	38	35	1,086	0,302	109	236	247	1026
Group 1-2-3-4	15	72	0,208					
Group 5-6	20	72	0,278					

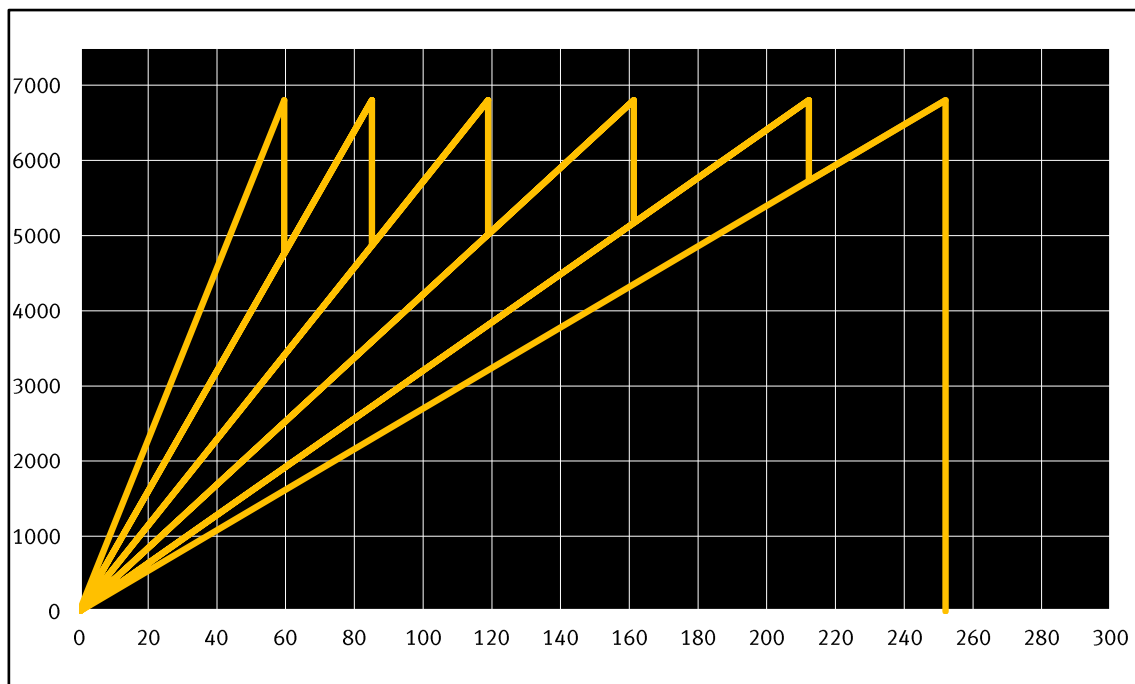

1.7 Chassis

Suspension features	Description	Remarks
Front damper Bilstein	2 way adjustable / Aluminium body	Clicks: 10 bump / 10 rebound
Springs front and rear	170/60/70-80-90-100-110-120	Eibach ERS-H
Front antiroll-bar	22x2 / 22x3	Adjustable in 6 positions
Rear bumper Bilstein	2 way adjustable / Aluminium body	Clicks: 10 bump / 10 rebound
Rear antiroll-bar	22x3 / 22x4	Adjustable in 6 positions
Front and rear tenders	60/60/2	

Brake features	Description	Remarks
Front calliper	AP Racing Monobloc 6 pistons	Special VW Group
Front disc	Ventilated ø378x34 mm	
Front pump	AP Racing 19,1 mm	
Front pads	Pagid RST 3	Thickness: 25 mm
Rear calliper	AP Racing 2 pistons	
Rear disc	Solid ø272x10 mm	
Rear pump	AP Racing 22,2 mm	
Rear pads	Pagid RS 4-4	
Rear press reducer	25 bar limiter	Car delivery
	AP Racing 7 position lever	Optional
Brake balance	Tilton balance bar	

Hand brake features	Description	Remarks
Hand brake	Hydraulic with mechanical locking	Acting on rear axle
Brake pump	AP Racing 15 mm	

Wheel features	Description
Rim dimension	10"x18" ET36
Rim centre lock	5 studs x 112 mm
Maximum tyre dimension recommended	27/65 R18
Tyre temp difference inside/outside	20°C
Minimum cold pressure recommended	1.2 bar

1.8 Electronic units

Electronic modules	Remarks	Software	Place
ECU	VW AG	Motorsport	Engine bay
Mechatronic	VW AG	Motorsport	Inside DSG
VAQ	VW AG	Motorsport	Connected to DSG
Low fuel pump control	VW AG	Series	Roll-cage
Fuel level display	SEAT Sport	Motorsport	Cockpit
Electronic steering rack	VW AG	Motorsport	Front subframe
ABS/ESP unit	VW AG	Not active	Cockpit
Gateway	VW AG	Series adapted	Cockpit
Blackbox	VW AG	Motorsport	Cockpit
MXG display/logger	AIM	Motorsport	Cockpit
Fusebox	SEAT Sport	Motorsport	Cockpit
Steering wheel module	SEAT Sport	Motorsport	Cockpit

Modules based in series					
	Engine ECU	Low fuel pump	Steering rack	ABS/ESP	Gateway
Specific software/mapping:	Yes	No	Yes	No	Yes
Specific codifications:	Yes	No	Yes	Yes	Yes
Interchangeable between cars:	Yes	Yes	Yes	Yes	Yes
Spare part ready for plug and play:	Yes	Yes	Yes	Yes	Yes
Modification allowed:	No	No	No	No	No

Notes:

- Use always spare parts from SEAT Sport. Although the mentioned parts derive from series cars, the software and codifications are different and modified by SEAT Sport.
- All series modules used on the car are based in the MQB platform. Through the diagnostic tools available on the VW AG dealers, it is possible to diagnostic any malfunction.

2 DRIVER CONTROLS

In this section, it is explained how the driver can handle the different commands and functions of the car within his range while driving.

2.1 Main panel

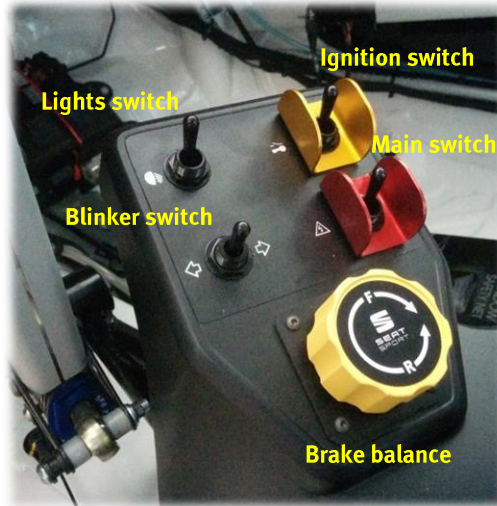

Function	Remarks
Ignition switch	It activates the power to all devices. The main switch has to be active.
Main switch	It activates the power supply.
Lights switch	It activates the low beam. High beam and flash activation buttons are placed on the steering wheel module.
Blinker switch	It activates the left and right turn lights. A green alarm on the display appears showing that the turn light is blinking.
Brake balance	Turning the balance wheel you can balance the brake pressure from front to rear or vice versa. Do not press the brake pedal while moving the balance wheel. Through the driver display you can check the front and rear brake pressure and the brake balance.

Notes:

- To start the car, always proceed in this order: main switch, wait until display has booted (SEAT Sport logo disappears), then ignition switch.
- The correct procedure to stop the car is the following:
 1. Stop the engine using only the yellow switch (ignition switch/KL-15).
 2. Wait at least 60 seconds.
 3. Switch off the car using the red switch (main switch/KL-30).
- If this procedure is followed correctly the OBD faults memory is saved and these faults can be checked with the diagnostics tools at any time thereafter. These faults are saved until the memory is deleted manually using the diagnostics program.













The diagnostic tool DiagRA-LE is recommended for customers to be able to check the cars.

2.2 Steering wheel module

The electronic steering wheel module permits activating different functions without removing hands from the steering wheel.

Some of the buttons have double functionality.



Button	Function	Remarks
	Radio	Driver voice activation Keep pushed to talk
	Full Course Yellow	4 variable* speeds (40/50/60/80) Short push to activate/deactivate
	120 limiter	Double short push to activate Single short push to deactivate
	Cockpit fan	Short push to activate/deactivate
	Change display page	Short push to change display page / rolling change
	Safety brake signal button	Allows moving the gear lever without pressing the brake pedal. IMPORTANT: the use of this button is under user responsibility, a bad use of it may cause fatal damages on the gearbox.
	Diff map change	Short push to roll diff map 1/2/3 Diff map number is shown on the AIM MXG display Map 1: Use when grip is high (new tyres or good grip) Map 2: Use when medium grip (used tyres) Map 3: Use when grip is low or rain
	Starter	Active if gearbox is in Neutral or the clutch is pressed Active if rpm < 500
	Pit limiter	4 variable* speeds (40/50/60/80) Active if rpm > 500 and speed > 5 km/h Short push to activate/deactivate
	Drink	Activates water pump Note: pump not supplied with the car
	Rain lights	Short push to activate/deactivate
	Wiper	Short push to roll low speed/high speed/deactivate
	Windscreen water	Long push to activate water splash + wiper activation
	High beam	Short push to flash Long push to activate/deactivate
	Tip up / Tip down	A led informs when tip up or down
	CAN info	Usual status: led off If there is a CAN Bus problem: led on

Notes:

- The FCY speed can be selected between the following speeds: 40, 50, 60 and 80. The speed can only be selected with the car stopped following this process: +30 switch ON, +15 switch OFF, keep FCY button pushed and select the speed using the gear shift paddles. The selected speed can be seen on the AIM MXG display.
- The Pit limiter speed can be selected between the following speeds: 40, 50, 60 and 80. The speed can only be selected with the car stopped following this process: +30 switch ON, +15 switch OFF, keep Pit limiter/Starter button pushed and select the speed using the gear shift paddles. The selected speed can be seen on the AIM MXG display.
- Although it is possible to uncouple completely the steering wheel from the column with the engine running, it is not advisable (causes fault messages on the OBD).

2.3 Speed limiter (Pit limiter/Full Course Yellow/120 limiter)

The speed limiter system allows limiting the car speed at a preselected value. There are five possibilities: 40, 50, 60, 80 and 120 km/h. This system is recommended for the pit lane area or Full Course Yellow (FCY) situations.

Process:

1. Select the desired speeds for each steering wheel button before starting the car and leaving the pits. Only the FCY and Pit limiter speeds are variable, the 120 limiter cannot be changed. The selected speeds are shown on the display.
2. Activate the desired speed limiter with the corresponding button. From this moment on throttle pedal may be fully pressed and the speed will be limited.
3. If the car speed is over the target, the engine torque may be cut. If the speed is below the target, torque will be applied till the speed is reached.
4. Make a short push on the selected speed limiter button on the steering wheel to deactivate the function.

2.4 Display alarms and shift lights

Car delivery shift lights and alarms configuration:

Gear	Shift Light 1	2	3	4	5	6	7	8	9	10	
1	6000	6000	6000	6200	6200	6200	6300	6400	6500	6600	⚙️



- **LED 1: continuous yellow:** Low oil pressure. If no red alarm follows you can continue. If alarm disappears you can continue pushing. Check the oil level when back into the pit.
- **LED 1: slow blinking green:** Left turn light is active.
- **LED 2: fast blinking red + POP UP:** Very low oil pressure. Big risk to break the turbo or to damage the engine. SEAT Sport recommends slowing down and entering to the pit-lane or stopping in a safe place.
- **LED 3: continuous purple:** Battery voltage low warning. You can continue, check the alternator and the alternator poly-V belt.
- **LED 4: continuous yellow:** Fuel pressure low warning. You can continue, check the fuel level.
- **LED 5: continuous yellow:** water temperature high. Pay attention, drive out of slipstream and keep an eye on the values. If no red alarm follows you can continue. If alarm disappears you can continue pushing.

- **LED 5: slow blinking green:** Right turn light is active.
- **LED 6: slow blinking red:** water temperature too high. Drive out of slipstream and keep an eye on the values. Some torque reductions will appear but you can continue.
- **LED 6: slow blinking red + POP UP:** Critical water temperature. SEAT Sport recommends slowing down and entering to the pit-lane or stopping in a safe place, to avoid damaging the engine.
- **LED 7: continuous white:** Gearbox oil temperature high. Drive out of slipstream and keep an eye on the values. You can continue.
- **LED 8: continuous blue:** Intake air temperature high. Drive out of slipstream and keep an eye on the values if not some torque reductions will appear. You can continue.
- **LED 8: slow blinking white:** Steering initialization needed (it will appear each time the car is switched on). Turning the steering wheel left and right should disappear. If not, there is a problem in the electrical steering rack.
- **LED 1 + LED 5: slow blinking red:** Pit limiter is active.
- **LED 1 + LED 5: slow blinking yellow:** Full Course Yellow is active.
- **LED 1 + LED 5: slow blinking blue:** 120 limiter is active.
- **LED 4 + LED 8: fast blinking green:** Hand brake is locked and engine started. Unlock it before trying to move the car.
- **LED 4 + LED 8: fast blinking green + POP UP:** Hand brake is locked while you are driving. SEAT Sport recommends unlocking the hand brake and entering to the pit-lane to check if the rear brake callipers have been damaged.

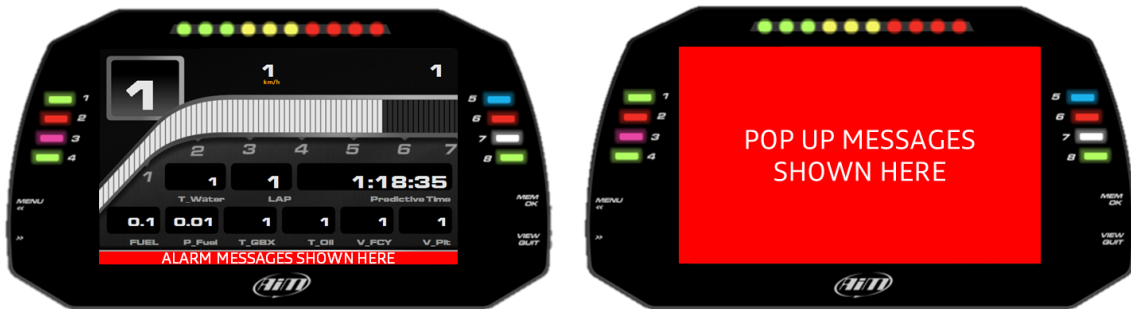

Note:

- It is possible to customize the alarms and shift lights through the RaceStudio3 software installed on a laptop.

2.5 Gearbox functioning

The shifting gear lever enables the different gearbox modes. The features for each mode are:



P - Parking mode:

- Use this mode to block the car by locking the transmission. Advisable for car parking in the pit lane or box area.
- It is possible to put on this P mode if the car is complete stopped and brake pedal pressed. **IMPORTANT: never try to put on P mode if the car is not completely stopped, it may cause fatal damages on the gearbox.**

- In case of brake switch malfunction, it is also possible to use the steering wheel (P) Safety brake signal button to put on or take out the P mode. **IMPORTANT: the use of this button is under user responsibility, a bad use of it may cause fatal damages on the gearbox.**
- To stop the car on track due to any technical issue, use the Neutral mode and lock manually the hand brake using the locking hook. The gearbox will not be locked, only the car due to the rear brake pressure generated by the hand brake pump.

R - Reverse mode:

- It is possible to put on this R mode if the car is complete stopped and brake pedal pressed.
- In case of brake switch malfunction, it is also possible to use the steering wheel (P) Safety brake signal button to put on or take out the P mode. **IMPORTANT: the use of this button is under user responsibility, a bad use of it may cause fatal damages on the gearbox.**

N - Neutral mode:

- In N mode, it is possible to move the car pushing externally (pit lane use).

D - Automatic driving mode:

- Not advisable for race. D mode is only advisable to move the car on the paddock zone. The gear shifting is working in a low range of engine speed.

S - Automatic sportive driving mode:

- Push the gear lever once backwards when lever is in D mode to engage S mode.
- Use S mode to drive with automatic shifting. It is possible to use the steering paddles simultaneously.
- It is possible to use S mode in the standing start process. The launch control will be active and gears will shift up automatically.
- It is possible to change the driving mode between D, S and Tip in any moment.

Tip - Manual driving mode:

- Push the gear lever once to the right when lever is in D position to engage Tip mode.
- The Tip mode is the most advisable for motorsport use, shifting by tipping the steering wheel paddles.
- Remember that using the Tip mode the shifting is only manual, when the engine reaches the rev limiter (6800 rpm) the power is limited but no automatic upshift will happen.
- Downshifting is protected preventing the engine from over-revs. If there is a downshift demand at too high revs the gearbox will not do it. A memory function will be save demand for one second.

2.6 Standing start procedure

Launch control system:

This system is automatic and only activated if wheels are absolutely stopped and brake pedal is pressed. The throttle pedal can be fully pressed and engine speed will be limited at 4200 rpm until the car starts moving.

There are many ways to manage standing starts; following the SEAT Sport recommendation is explained.

Process:

1. After the grid formation lap, stop completely the car on the grid line pushing the brake pedal.
2. Gear lever has to be in S or Tip mode. If the formation lap is done using one of these modes, it is not necessary move the gear lever.
3. When the red starting lights begin, maintaining the brake pedal fully pressed, go on gas pedal flat out. Engine will limit at 4200 rpm.
4. When the red light turns off, release the brake and control the start with throttle pedal. Once the car starts moving the rev limiter will disappear so be careful to avoid wheel spin.

Notes:

- It is possible to start at lower engine speed using the launch control system, just get the desired engine speed playing with the throttle pedal. Advisable not bellow of 3500 rpm.
- Take care of the time you are using the system. The clutch and the engine may take temperature very fast. Recommendation no more than 6 seconds of start rev limiter use.

- Starting in S mode is necessary to release a little bit the throttle pedal from full gas to disable the launch system. After this, using the S mode, upshift is automatic.
- During testing, it is strongly recommended to do two laps between each start to cool down the clutch.

2.7 Rear brake pressure proportioning valve

The lever type proportioning valve provides 7 distinct settings from which to produce the most suitable braking ratio.

The brake balance should be biased towards the rear so that with the valve piped in to the rear line and set in position 7 where virtually no reductions occurs, the balance is as much to the rear as will ever be needed. Moving the control lever to a lower setting will progressively reduce the rear line pressure giving more bias to the front, for use when more grip is available.

When the proportioning valve is fitted in the standard position on the car, position 7 is with the lever max backwards and position 1 with the lever max forward.

Note:

- This valve is not a car delivery part. However, cars can be ordered with it fitted or it can be bought later as spare kit, see Spare Parts Catalogue for more information.

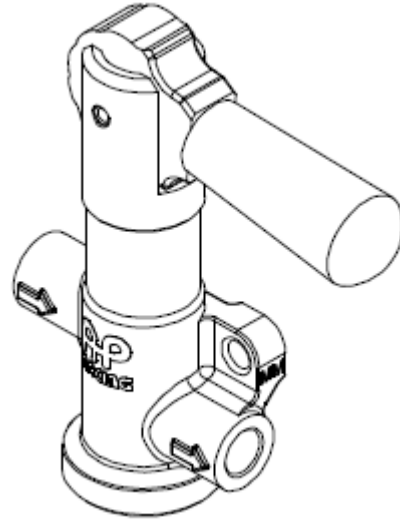

2.8 Driver has to consider

- Learning and memorizing the steering wheel buttons placements and functions will allow drivers a faster action and will help them to keep focused on the track.
- Warm up the engine before starting. The minimum water temperature recommended before loading the engine is 80°C.
- Check the brake pedal stiffness when car is stopped or on the acceleration way.
- Warm up tyres before attacking. Without blankets use, the rear tyres may need 2 laps to get warm and the car is very sensitive on this.
- Shift up gears when shift light indicates. The shifting lights have been optimized taking into account gear ratios and engine power.
- Shift down gears without stress. If a downshift is required at too high revs it will be electronically rejected at it will not happen.
- In-laps: cool down brakes progressively and engine water to avoid thermal shocks. Do not stop on the pit lane pressing the brake pedal when coming from the track.
- If a pop-up message appears it is strongly recommended to stop the car as soon as possible on a safe place.
- If for any reason it is necessary to drop out the car on the track, leave the gearbox in neutral to save the transmission in case of being towed.
- It is important to bed discs as follows to get their maximum life:
 - When possible bed discs with used pads.
 - To reduce thermal shock during bedding, the brake ducts may be 50% taped off.
 - Apply the brakes gently at low speed a few times to ensure a correct installation.
 - Apply the brakes moderately, (progressively up to 50% race speed, 25% race pressure), for 10-20 applications to ensure above 80% pads face contact with disc.
 - Progressively build up to about 70% of race speed and 50% of race pressure. Then, apply brakes for approximately 25 applications.
 - Progressively start reducing again the brake pressure to cold down the brakes slowly during the in lap. Do not just stop braking because this can produce a very fast cooling and cause cracks because of thermal shocks.
 - When returning to the track, come up progressively to race speed and pressure.

3 ELECTRONICS

3.1 AIM MXG

MXG is the AIM dash-logger designed to acquire and display in FHD data coming from your ECU, the internal accelerometer and gyro, as well as from the GPS module, analog/digital inputs and predefined math channels.

Downloading data can be done through a data download cable, a memory stick or using the available Wi-Fi features.

Performance and data acquired can also be incremented adding expansion modules. Using the specific AIM on-board camera SmartCam it is possible to overlay on videos the data sampled by the logger.

To see the lap times it is necessary to insert the track where you are running. Track load has to be done by the RaceStudio3 software.

RaceStudio3 software, latest MXG firmware and documentation available on AIM website:

<http://www.aim-sportline.com/eng/download/index.htm>

MXG user guide available on AIM website:

http://www.aim-sportline.com/download/doc/eng/mxs-mxg/MXG_user_guide_101.pdf

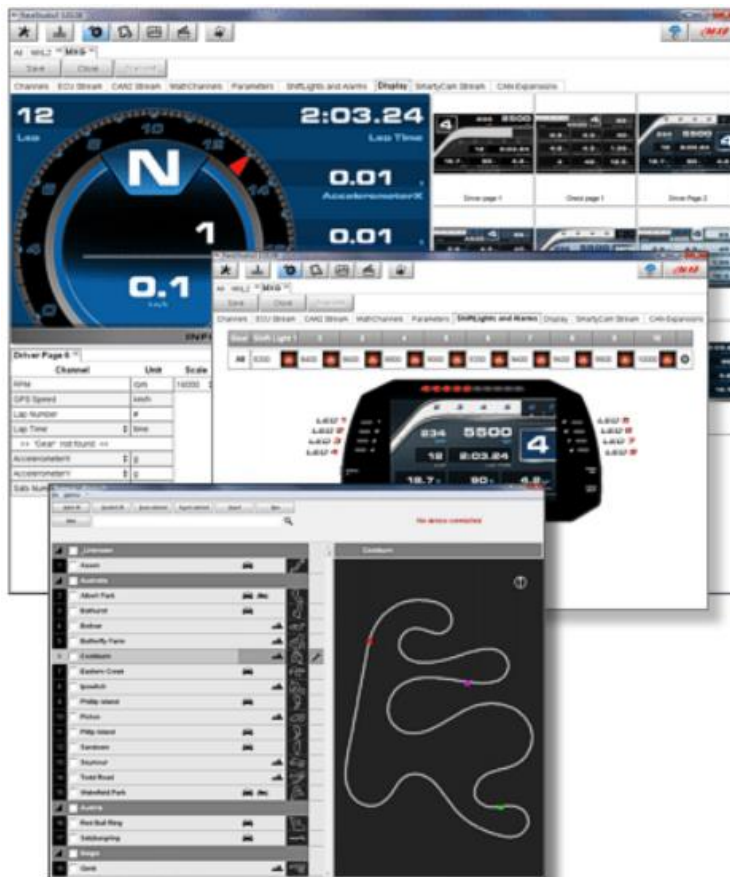

Shift lights and alarms:

1. On the top of the display there are ten gear flash leds that can be freely configured. The rpm value at which to turn it on and the colour can be defined. Gear dependent lights can be also defined.
2. On both sides of the screen there are eight alarm leds that can be freely configured. The conditions to turn them on and off and the colour can be defined. Also messages on a red ribbon in the lower part of the screen and completely screen pop-up messages can be defined.



Note:

- **IMPORTANT:** the change of the alarms or shift lights is under user responsibility. Car is delivered with SEAT Sport recommendation. Before changing them it is advisable to do a backup of the standard configuration.

3.2 MXG connection schemes

Scheme 1: Data-logger standard connection scheme (car delivery).



Scheme 2: Data-logger connection scheme with Smarty-cam and expansion module (example).

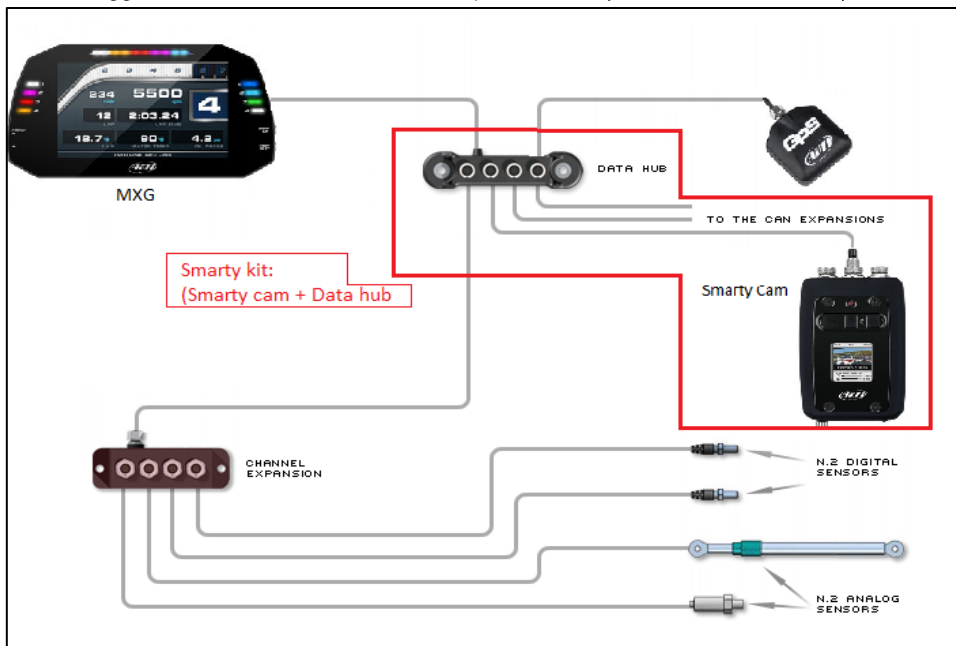

Features	Remarks
Lap-trigger	The MXG system uses only GPS signal.
Circuit	Through the RaceStudio3 software is possible to activate all the circuits in the world. It is also possible to create and load a new circuit.
Extra sensors	In case of adding extra sensors, they have to be connected to an expansion module. This expansion module has to be connected through the data hub as shown in the scheme 2.

Notes:

- Channel expansion module and sensors are available through AIM dealers, not SEAT Sport.
- If for any reason it is necessary to send data acquisition files to SEAT Sport, following data file extensions must be sent: .drk, .gpk and .xrk.

3.3 Data acquisition

AIM-MXG channel list:

Channel name	Description	Unit	Recommended scale
P_TURBO	Boost pressure	bar	0 ... 3
T_ENG_AIR	Intake air temperature	°C	20 ... 75
T_ENG_OIL	Engine oil temperature	°C	80 ... 150
T_ENG_WATER	Engine coolant temperature	°C	70 ... 125
T_AIR	External air temperature	°C	12 ... 45
RPM_ENG	Engine speed	rpm	1000 ... 7000
FLAG_BRAKE	Brake lights	on/off	0 ... 2
P_BRK_FRONT	Front brake pressure	bar	0 ... 100
P_BRK_REAR	Rear brake pressure	bar	0 ... 100
BRK_BALANCE	Brake balance	%	0 ... 100
P_ENG_OIL	Engine oil pressure	bar	1,5 ... 5
P_ENG_FUEL	Fuel low pressure	bar	0 ... 7
FUEL_LEVEL	Fuel level	l	0 ... 110
FUEL_CONS	Fuel consumed	l	0 ... 110
S_FUEL	Fuel remaining time	min	0 ... 120
N_FUEL	Fuel remaining laps	#	0 ... 80
LAP_CONS	Fuel lap consumption	l /lap	0 ... 3
POS_PEDAL	Gas pedal position	%	0 ... 100
TIP_DOWN	Tip down	Sign	0 ... 2
TIP_UP	Tip up	Sign	0 ... 2
G_CH_Y	Lateral acceleration	G	-2,5 ... 2,5
G_CH_X	Longitudinal acceleration	G	-1,6 ... 1,6
W_CH	Yaw rate	°/s	-50 ... 50
V_WHL_RL	RL wheel speed	km/h	0 ... 260
V_WHL_RR	RR wheel speed	km/h	0 ... 260
V_WHL_FL	FL wheel speed	km/h	0 ... 260
V_WHL_FR	FR wheel speed	km/h	0 ... 260
V_WHL_REF	ESP reference speed	km/h	0 ... 260
V_STW_LIMIT	Pit limiter speed	km/h	20 ... 100
V_STW_FCY	Full Course Yellow speed	km/h	20 ... 100
A_STE	Steering angle	°	-200 ... 200
FLAG_STW_OUT1	Steering wheel button state	#	0 ... 8
FLAG_STW_OUT2	Steering wheel button state	#	0 ... 8
FLAG_STW_OUT3	Steering wheel button state	#	0 ... 8
FLAG_FBX_RELAY1	Fusebox relay 1 state	#	0 ... 8
FLAG_FBX_RELAY2	Fusebox relay 2 state	#	0 ... 8
FLAG_FBX_5	Fuse state 5	#	0 ... 8
FLAG_FBX_4	Fuse state 4	#	0 ... 8
FLAG_FBX_3	Fuse state 3	#	0 ... 8
FLAG_FBX_2	Fuse state 2	#	0 ... 8
FLAG_FBX_1	Fuse state 1	#	0 ... 8
I_FBX_MAIN	Main current	A	10 ... 40

I_FBX_TURNLIGHT	Turn light current	A	0 ... 10
EXTERNAL VOLTAGE	Battery Voltage	V	8 ... 15
POS_GBOX	Gearbox position	#	0 ... 14
N_DSG_GEAR	Gear	#	0 ... 8
POS_GEAR_LEVER	Gear lever position	#	0 ... 14
T_DSG_OIL	Gearbox oil temperature	°C	80 ... 145
POS_DIF_MAP	Diff map position	#	1 ... 3
T_DIF_LAMELLA	Diff temperature	°C	80 ... 145
I_DIF_PUMP	Diff current consumption	A	0 ... 10
TORQ_DIF_REF	Requested diff torque	Nm	0 ... 2000

GPS channels	Description	Unit
GPS_Speed	Speed	km/h
GPS_Nsat	N° of satellites	#
GPS_LatACC	Lateral acceleration	G
GPS_LonACC	Longitudinal acceleration	G
Altitude		m
Luminosity	Display brightness	%
Odometer		km

The values shown in the following table are the standard approximate values at 20°C air temperature for main car control channels.

Channel	Idle speed*	Values at T _{air} 20°C	Maximum value**
P_TURBO	0 bar	2.7 bar	2.99 bar
P_ENG_FUEL	4.1 bar	4.3 bar	6 bar
P_ENG_OIL	2 bar	3.6 bar	5 bar
T_ENG_AIR	40°C	42°C	>75°C
T_ENG_OIL	80°C	122°C	>145°C
T_ENG_WATER	90°C	92°C	>115°C
T_DSG_OIL	40°C	120°C	>142°C

Notes:

- * These values can change depending on car's engine temperature. Those are approximate values when T_{ENG_WATER} is 90°C after having warmed the car from cold always at idle speed.
- ** The maximum values underlined in yellow show the values before performance restrictions or protection modes are applied.

3.4 Fusebox

The fusebox is an electronic box that controls the power supply to practically all devices. Internally, the thermal fuses reset automatically, so changing a fuse will never be necessary. In case of malfunction it has to be sent to SEAT Sport.

It is also possible to check if a fuse has blown in the fusebox, so you will know if the current or signal was sent.

There are three ways to check the correct functioning:

- Live measures view using RaceStudio3.
- Checking the fusebox control channels in RaceStudio Analysis.
- Checking the red LEDs on the fusebox.

If a malfunction is detected, it is necessary to first check the corresponding wiring or the device.



In the following tables the fusebox analysis information is shown:

- Channel name: There are 7 channels to analyse.
- Bit number: Each channel is able to control 8 fuses.
- Data value: Is the value you can check on data acquisition.

Channel name	Bit number	Data value	Description
FLAG_FBX_F5	bit8	-----8	Sadev pump
	bit7	-----7-	HR-ECU
	bit6	-----6--	HR-Fuel pump
	bit5	----5---	Starter
	bit4	---4----	Radio
	bit3	--3-----	HR-Lambda
	bit2	-2-----	HR-Miscellaneous
	bit1	1-----	HR-Injectors
FLAG_FBX_F4	bit8	-----8	MR-ignition coils
	bit7	-----7-	Sadev-ELV
	bit6	-----6--	Drink
	bit5	----5---	Switch panel / Aux. data connector
	bit4	---4----	Steering wheel
	bit3	--3-----	Gear Lever / GCU
	bit2	-2-----	Diagnosis connector
	bit1	1-----	Power steering ECU
FLAG_FBX_F3	bit8	-----8	ECU
	bit7	-----7-	Front fan
	bit6	-----6--	MXG
	bit5	----5---	Blackbox / Gateway
	bit4	---4----	Differential
	bit3	--3-----	+30 Aux. connector
	bit2	-2-----	DSG
	bit1	1-----	ABS ELV

FLAG_FBX_F2	bit8	-----8	Wiper
	bit7	-----7-	Turn light
	bit6	----6--	Diagnosis connector / +15 aux. connector
	bit5	---5---	Cockpit fan
	bit4	---4---	Window
	bit3	--3----	Head lights
	bit2	-2-----	Transponder
	bit1	1-----	+15 signal
FLAG_FBX_F1	bit8	-----8	Wiper pump
	bit7	-----7-	Brake light
	bit6	----6--	Low beam
	bit5	---5---	Day light
	bit4	---4---	Low beam
	bit3	--3----	Rear light
	bit2	-2-----	Rain light left
	bit1	1-----	Rain light right
FLAG_FBX_RELAY2	bit8	-----8	
	bit7	-----7-	
	bit6	----6--	Turn light L
	bit5	---5---	Turn light R
	bit4	---4---	Cockpit fan
	bit3	--3----	M relay
	bit2	-2-----	H relay
	bit1	1-----	Starter
FLAG_FBX_RELAY1	bit8	-----8	Drink
	bit7	-----7-	Wiper pump
	bit6	----6--	Brake light
	bit5	---5---	High beam
	bit4	---4---	Rain light
	bit3	--3----	Low beam
	bit2	-2-----	+15 signal
	bit1	1-----	Turn light

Example:

- In the acquisition screenshot below is shown the channel FLAG_FBX_1 in green. The value is 7 when braking and 0 when no braking. In this case, the conclusion is that there is a problem on the brake light line.

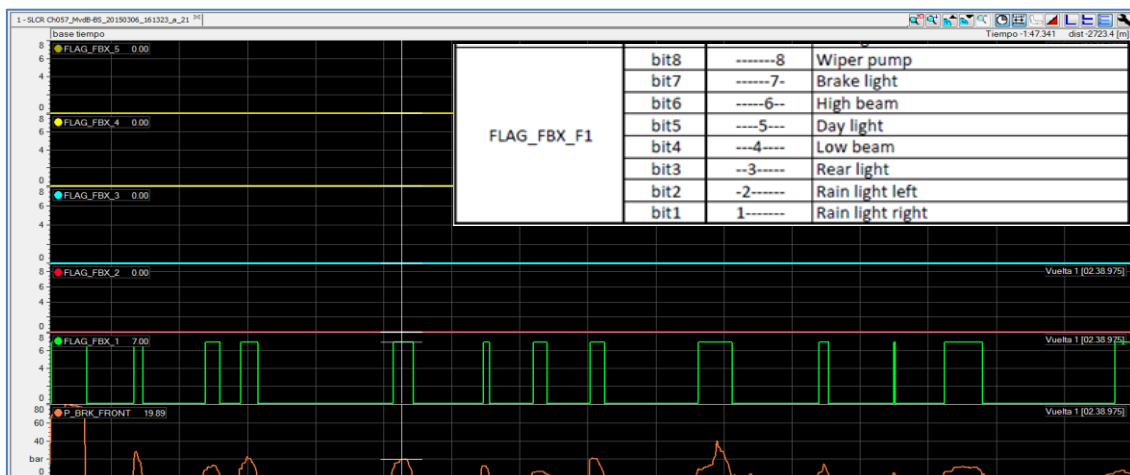

3.5 Fuel level display

All new SEAT LCR TCR cars have a fuel display to control the fuel remaining at the tank. It is tied to the roll cage in the rear right door area. The display has to be set after each refuelling. This setting is very important to get the correct fuel level because it is calculated by the fuel consumption sent from the engine ECU.

- There is a light sensor for automatic brightness trimming.
- Two sensitive zones below the four digits allow menu navigation.
- It is important not to touch the front panel when it is switching on due to the initial capacitance setting during start up.
- Also take special care wiping with hand the front panel if device is switched on.
- Electrostatics charge could affect the sensitive touch and set undesired actions.



Terminology:

Following, the terminology description to understand future command tables:

- **Llp:** Left long push (>1s)
- **Rlp:** Right long push (>1s)
- **Lsp:** Left short push (<1s)
- **Rsp:** Right short push (<1s)
- **STout:** Short Timeout (1s)
- **LTout:** Long Timeout (8s)

Fuel level adjustment:

This menu allows the following possibilities:

- Set fuel level to full tank value.
- Add/remove a fuel quantity to the actual value.
- Set an absolute quantity (litres without decimal).

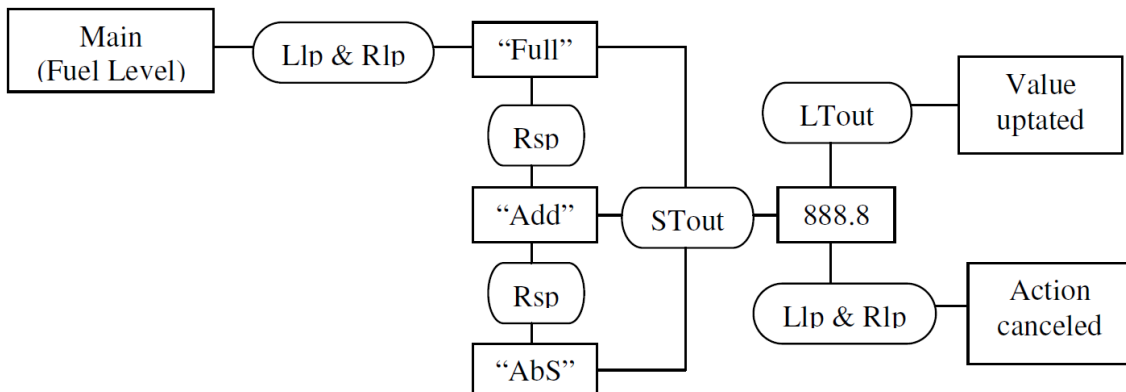

- When the value is shown (and blinking), a right short push increases this value litre by litre and a left short push decreases this value.
- Maintaining right/left long push, the value is increased/decreased 10 litres by 10 litres.

Set Full level value:

This menu allows setting the maximum tank level or predefined fuel level.

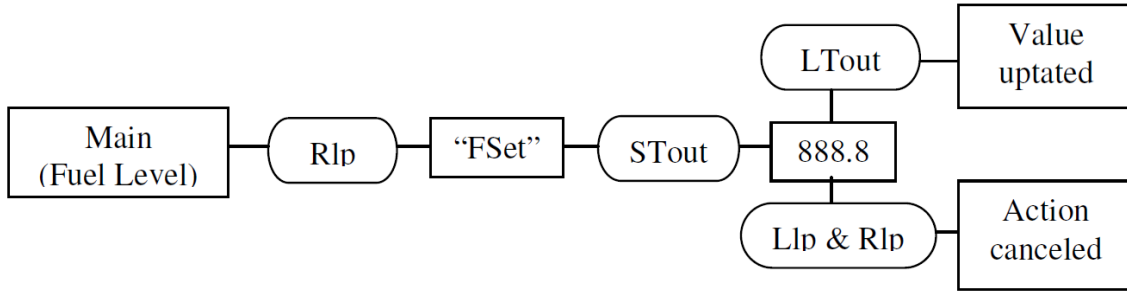

Brightness and bar graph set:

It is possible to modify the brightness and bar graph settings.

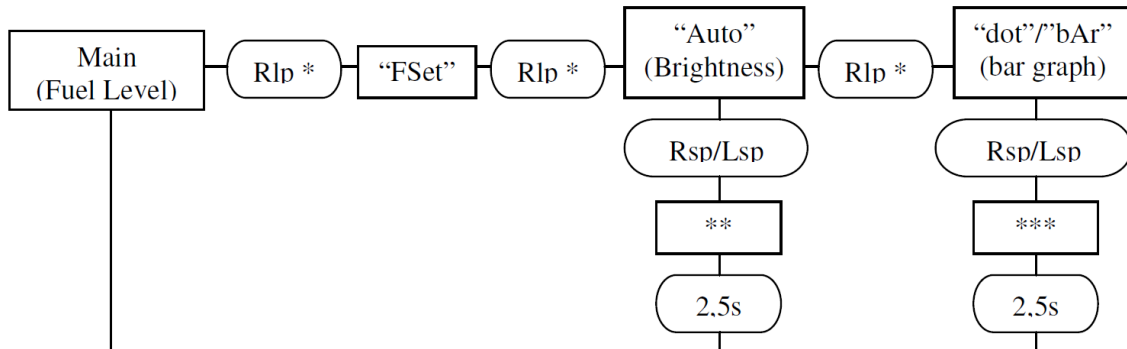

- * Long left push will scroll menu on the other side.
- ** "Auto" will adjust automatically the brightness. Else, use right / left touch to increase / decrease light level.
- *** "dot" mode will light on only one led on the bar graph. "bAr" mode will light on all leds beginning from the left side up to the level point. Note that the last led matches with the Full value set.

3.6 Auxiliary connectors

The main car wiring loom is prepared with some auxiliary connectors to make easier the connection of auxiliary devices.

Free connectors inside the cockpit

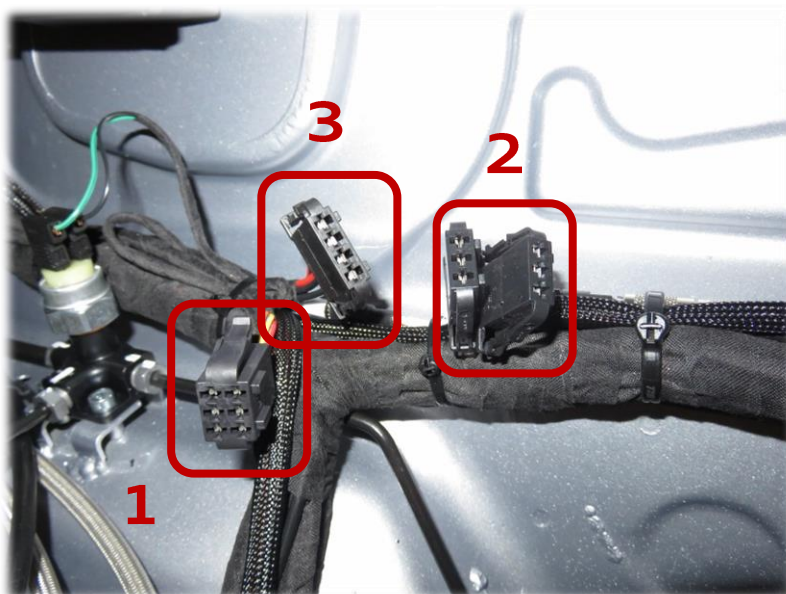

#1: Auxiliary power supply

This connector is placed in the driver cockpit above the central tunnel (front). It could be used for user requirements such as connecting the TCR scrutineering logger.

Auxiliary power supply		
Matching connector		191 972 733
Pin-out		Terminal
1	+30 up to 8A	FS 2,8 x 0,8
2	GND	FS 2,8 x 0,8
3	CAN H traction	FS 2,8 x 0,8
4	CAN L traction	FS 2,8 x 0,8
5	CAN H chassis	FS 2,8 x 0,8
6	CAN L chassis	FS 2,8 x 0,8

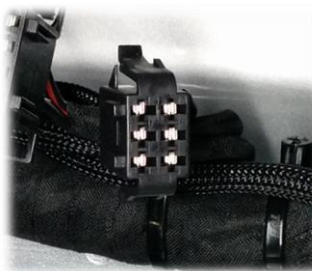

#2: Auxiliary analogic sensors

Two connectors are available connected to the dash logger.

Auxiliary analogic sensors		
Matching connector		191 972 713
Pin-out		Terminal
1	5v	FS 2,8 x 0,8
2	signal	FS 2,8 x 0,8
3	GND	FS 2,8 x 0,8



#3: Additional power supply

It can be used for any requirement.

Additional power supply		
Matching connector		1j0 972 714
Pin-out		Terminal
1	+30 up to 8A	FS 2,8 x 0,8
2	+15 up to 5A	FS 2,8 x 0,8
3	GND	FS 2,8 x 0,8
4	GND	FS 2,8 x 0,8



#4 and #5: Radio and drink

Behind the driver seat there are two free connectors associated with the steering wheel module. Connecting here radio and drinking systems, both can be used through the steering wheel module.

Radio connector		
Matching connector		AMP Super-seal 4-way 282106-1
Pin-out		Terminal
1	PTT	183024-1 or 183036-1
2	PTT	183024-1 or 183036-1
3	+30 up to 8A	183024-1 or 183036-1
4	GND	183024-1 or 183036-1



Drink connector		
Matching connector		AMP Super-seal 2-way 282104-1
Pin-out		Terminal
1	up to 2.5A	183036-1
2	GND	183036-1

#6: Power supply cut

There is a fusebox power supply connector, so in case of disconnection cuts all devices power supply.

You can unplug it in case of transport or for a more safe disconnection in case of workshop big jobs.

See connector placement above the fusebox main connectors on the picture beside.



Free connectors on the engine bay

#7: Transponder

This auxiliary connector is placed behind the right front headlight. All SEAT LCR TCR cars are provided without transponder.

Transponder		
Matching connector		357 972 762
Pin-out		Terminal
1	12v	FS 2,8 x 0,8
2	GND	FS 2,8 x 0,8

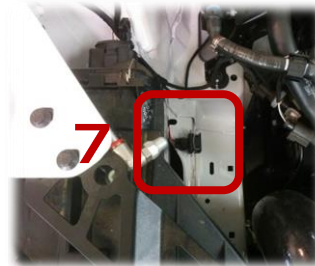

3.7 Fire extinguisher

All SEAT LCR TCR cars are delivered with an OMP fire extinguisher placed on the boot area. Fulfilling all FIA safety regulations, the extinguisher can be detonated from the cockpit area using the push button of the control box placed in the main console or from the outside by a switch on the lowest part of the windscreen.

The extinguisher is equipped with the mandatory anti-torpedo bracket bolted to the chassis.



Safety notes:

- Check the inner press bottle periodically. It has to be in the green area.
- Check periodically that the 9V inner battery is in good conditions.
- Do not forget to toggle ON the control box switch before sending the car into the track.

4 SETTING ADJUSTMENTS

4.1 Standard set-up

SEAT LCR TCR DSG		STANDARD SET UP		SEAT SPORT	
CAR INFORMATION		TRACK INFORMATION		DATE	
Chassis	-	Circuit	-	DATE	-
Engine	-	Lenght	-	FROM	-
Gearbox	-	Driver	-	TO	-
CAR CONFIGURATION		FRONT	REAR	POWER TRAIN	
RIDE HEIGHT	83		123	ENGINE	
MEASUREMENT POINT	Front subframe		Rear subframe	RPM	Power
DAMPER SETTINGS		FRONT	REAR	6600	350 hp
MAIN SPRING	170/60/110		170/60/90		R efect
TENDER	60/60/2		60/60/2		325
ASSEMBLY LENGHT	-		-	TRANSMISSION	
DAMPER ON UPRIGHT	Pos 0		-	Gear	Ratio
BUMP STOP	20 mm (5000 N/4 mm)		35 mm (5000 N/4 mm)		Vmax
BUMP CLICKS	5		5	1	13//38
REBOUND CLICKS	5		5	2	22//45
ARB SETTINGS		FRONT	REAR	3	28//41
TYPE	22x3		22x3	4	38//41
POSITION	M - M		M - M	5	32//35
WHEELS SETTINGS		FRONT	REAR	6	38//35
RIM	18"x10" ET36		18"x10" ET36	cwp 1-4	15//72
SPACER	-		-	cwp 5-6	20//72
TYRES	MICHELIN PILOT S9L 27/65 R18			DIFFERENTIAL	
HOT TYRE PRESSURE	2,0		2,0	VAQ	
BRAKES SETTINGS		FRONT	REAR	DIFF MAP	
MASTER CYLINDER	AP 19,1		AP 22,2	1	
BRAKE PADS	PAGID RST 3		PAGID RS 4-4		
BRAKE DISCS	378x34		VW AG 272x10		
BRAKE BALANCE	15/12		AP 7 pos valve (P3)		
AERO				HAND BRAKE	
WING POSITION	0°			MASTER CYLINDER	
ALIGNMENT				AP 15,0	
	FRONT			WEIGHT (kg)	
	LEFT	RIGHT		DRIVER	-
CAMBER	4,5°	4,5°		FUEL	-
TOE	1.0 mm OUT	1.0 mm OUT		FRONT	
	REAR			LEFT	RIGHT
CAMBER	4,0°	4,0°		-	-
TOE	0	0		REAR	
				TARGET (no fuel)	
				-	-
	FRONT	CROSS			
	REAR	LEFT			
NOTES					
Alignment with 75 kg + 20 kg of fuel					

Notes:

- Due to production issues, this recommended set up may differ from the car delivery set up. SEAT Sport recommends doing your own check.
- The use of ballast as fuel weight during set-up process is recommended to ensure the cross weights.

4.2 Steering rack centring

As the steering rack is electric, the steering angle sensor has to be electronically aligned with the wheels at the aligning time.

Before aligning, it is necessary fix the steering wheel. To do it, it is recommended to use straps fixed between the roll cage and the steering wheel.

The use of a rack centring stopper tool is not recommended because it is difficult to get the steering angle sensor at 0 deg. The most important is to obtain the toe alignment with the sensor at 0 deg.

Proceed as following:

- Switch on main and ignition switches.
- Turn left and right to get the steer angle signal initialized.
- Fix the steering wheel when the steer angle is 0 deg.
- Switch off the ignition and main.
- Proceed now with the alignment jobs.

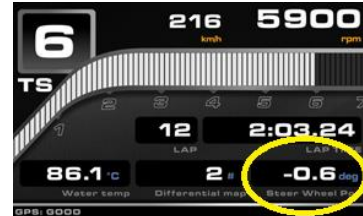

Note:

- With this process the steering angle signal will be 0 deg with the wheels aligned. This is very important for the steering assistance and for the electronic slip differential behaviour.

4.3 Front camber and toe adjustments

The front suspension is very special on this car due its kinematic characteristics. To reach the front suspension set-up value is recommended to proceed as following:

1. Car ride height: put the ride height at your choice through damper/spring adjustments.
2. Camber: to change the camber is recommended to move the steering rod first. The camber will change quickly.
3. Toe: to change the toe enlarge or reduce the wishbone adjustment.
4. Check: adjust a second time if necessary.

Note:

- Although this process seems strange, it is the best and faster way to obtain the camber and toe adjustments.

Underneath the front wishbone there is a bolt to control the adjustment movement. Unblock the four screws that are fixing the camber regulator plate and proceed to the adjustment.



Notes:

- After any intervention, fix the wishbone regulator plate bolts in the right tighten.
- Maintain the wishbone regulation plate clean and oiled between plates.

Front regulation table:

Camber	Toe regulation	Wishbone regulation 1,5 turns = 10° camber
-5,8°	9,5 turns	12 turns
-5,5°	7 turns	8,3 turns
-5°	3,5 turns	4,5 turns
-4,5°	0	0
-4°	-3,5 turns	-4 turns
-3,8°	-6 turns	-7 turns

Note:

- Take care with the maximum and minimum camber. Although physically the camber adjuster can reach higher values, it is not recommended due the drive shaft limitations.

4.4 Rear camber and toe adjustments

To reach the rear suspension set-up value is recommended to proceed as following:

1. Car ride height: put the ride height at your choice through damper/spring adjustments.
2. Camber: to change the camber is recommended to move the boomerang arm.
3. Toe: to change the toe enlarge or reduce the rear arm.
4. Check: Adjust a second time if necessary.



Notes:

- The rear camber regulation does not have relation with the toe movement, so it is possible to change rear camber without any toe movement.
- After the camber adjustment job, check that the ball-joint is placed in the middle of its housing.

Rear camber regulation table:

Camber	Arm regulation
-2°	1,5 turns
-2,5°	1 turns
-3°	0,5 turns
-3,5°	0
-4°	-0,5 turns
-4,5°	-1 turns
-5°	-1,5 turns

4.5 Suspension

To set-up the suspension, the following spring range can be used in both front and rear axles:

Springs	Nm	Remark
170-60-120	120	Front use recommended
170-60-110 (car delivery - front)	110	Front use recommended
170-60-100	100	Front use recommended
170-60-90 (car delivery - rear)	90	Rear use recommended
170-60-80	80	Rear use recommended
170-60-70	70	Rear use recommended

The dampers specifications are the following:

Front dampers
Aluminium outer housing Bilstein damper
2-way adjustable with 10 clicks in bump and 10 in rebound
110 mm travel
20 mm upright height regulation
20 mm bump stop (5000 N / 4 mm)



Upright height Adjuster
0mm (-10mm to +10mm)

FORCE ADJUSTMENT

Red Adjuster (Rebound)
Blue Adjuster (Bump - Compression)
Pos 1-soft to 10-hard.



Rebound (Red ---> Rebound)
Compression (Blue ---> Bump)

Rear dampers
Aluminium outer housing Bilstein damper
2-way adjustable with 10 clicks in bump and 10 in rebound
119 mm travel
35 mm bump stop (5000 N / 4 mm)



FORCE ADJUSTMENT

Red Adjuster (Rebound)
Blue Adjuster (Bump - Compression)
Pos 1-soft to 10-hard.



Rebound (Red ---> Rebound)
Compression (Blue ---> Bump)

Adjustment range of front dampers:

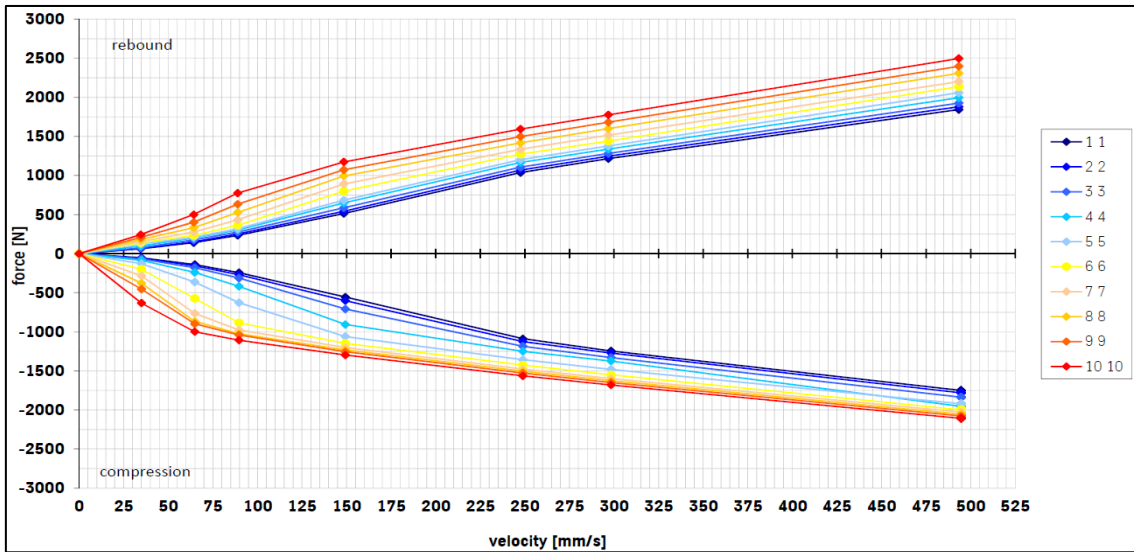

Adjustment range of rear dampers:

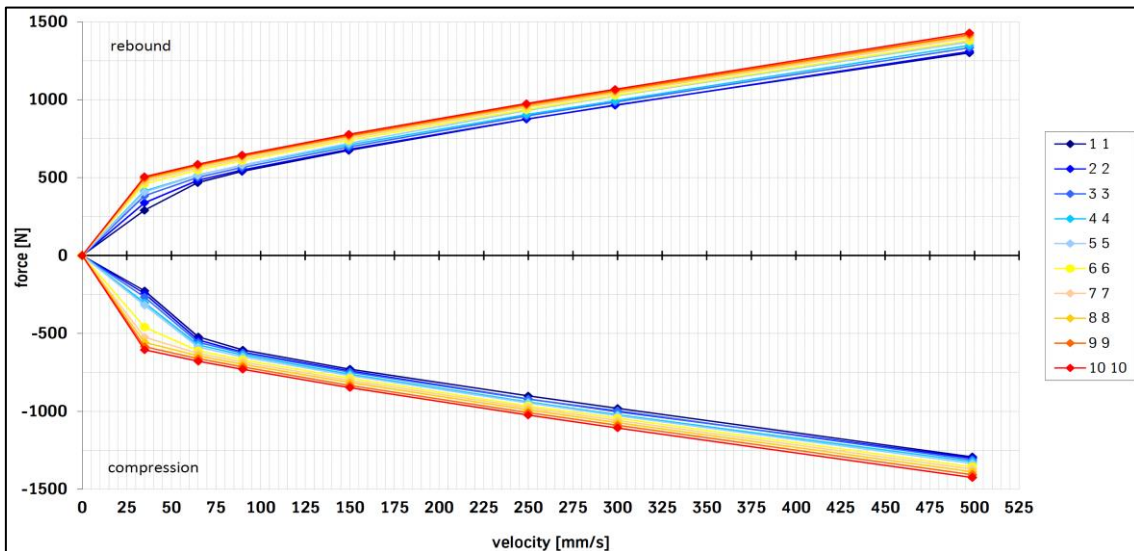

4.6 Anti-roll bars

Front anti-roll bars available: 22x2 and 22x3. **Car delivery: 22x3.**

FRONT ARB		
\varnothing (mm)	22	22
Thickness (mm)	2,0	3,0
Chassis Roll Stiffness from ARB		
Hard (Nm/°Chassis)	1548	2021
Mid (Nm/°Chassis)	991	1293
Soft (Nm/°Chassis)	688	898

Rear anti-roll bars available: 22x3 and 22x4. **Car delivery: 22x3.**

REAR ARB		
\varnothing (mm)	22	22
Thickness (mm)	3,0	4,0
Chassis Roll Stiffness from ARB		
Hard (Nm/°Chassis)	1252	1454
Mid (Nm/°Chassis)	1061	1232
Soft (Nm/°Chassis)	898	1043

4.7 Kinematics

	Front	Rear
Wheel ratio	1 mm wheel / 0,9 mm damper	1:1

FRONT

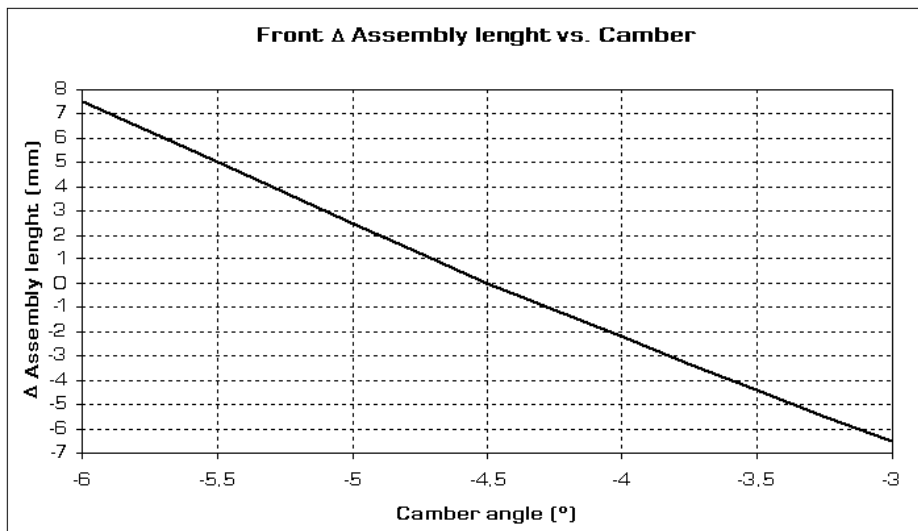
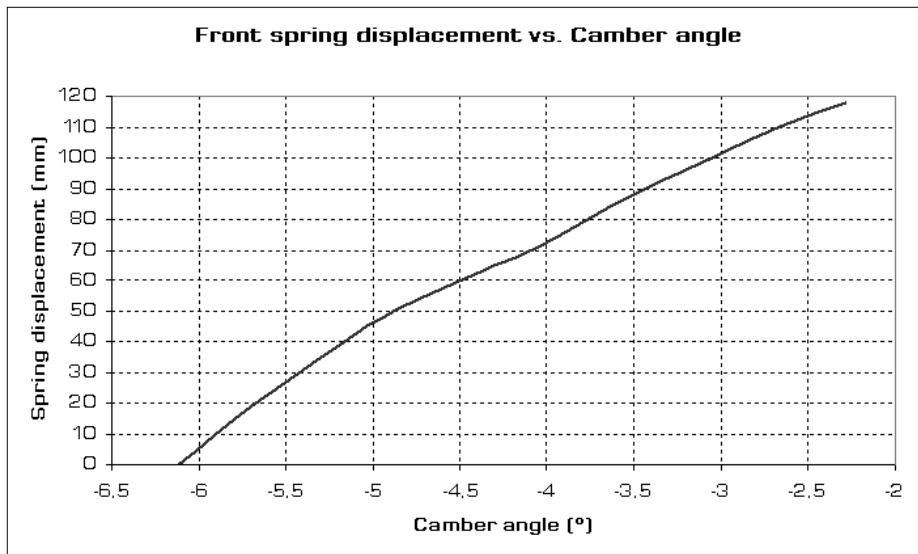
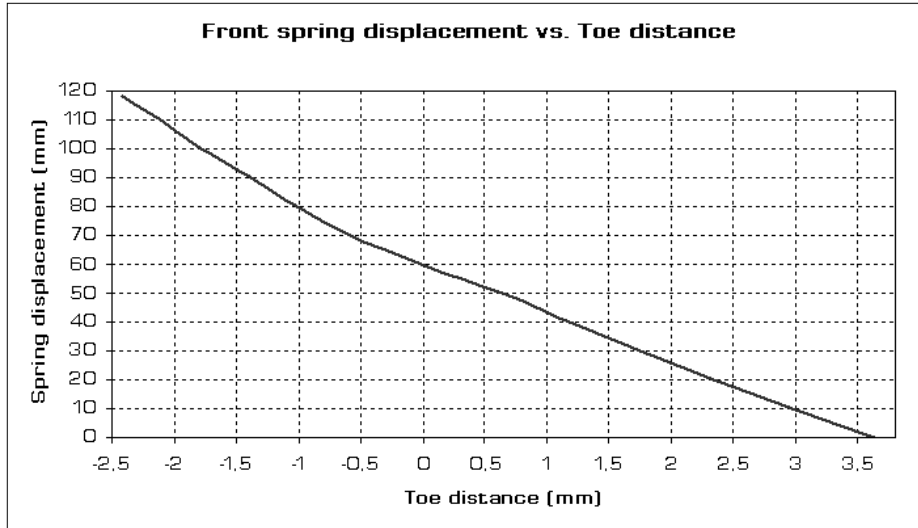

REAR

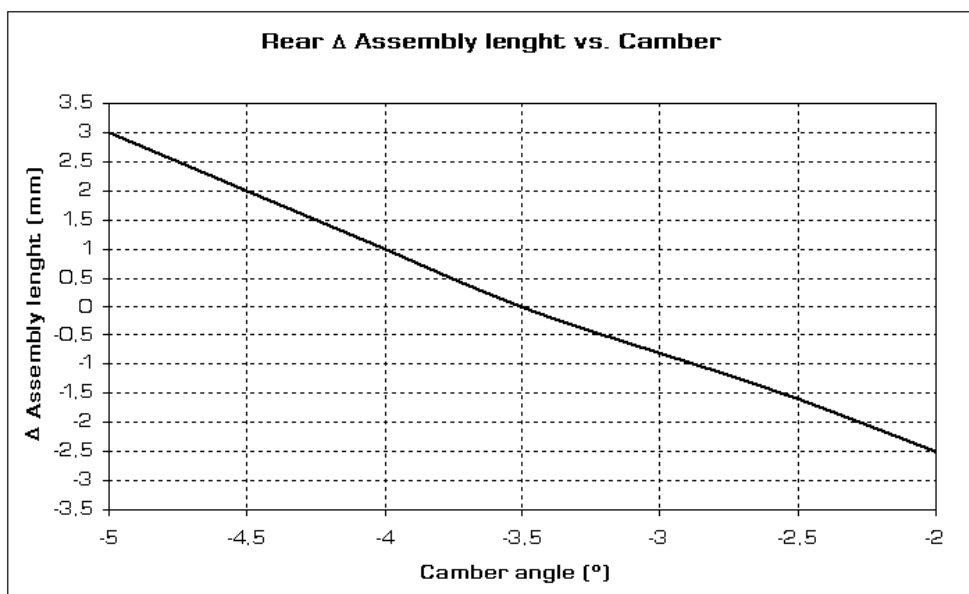
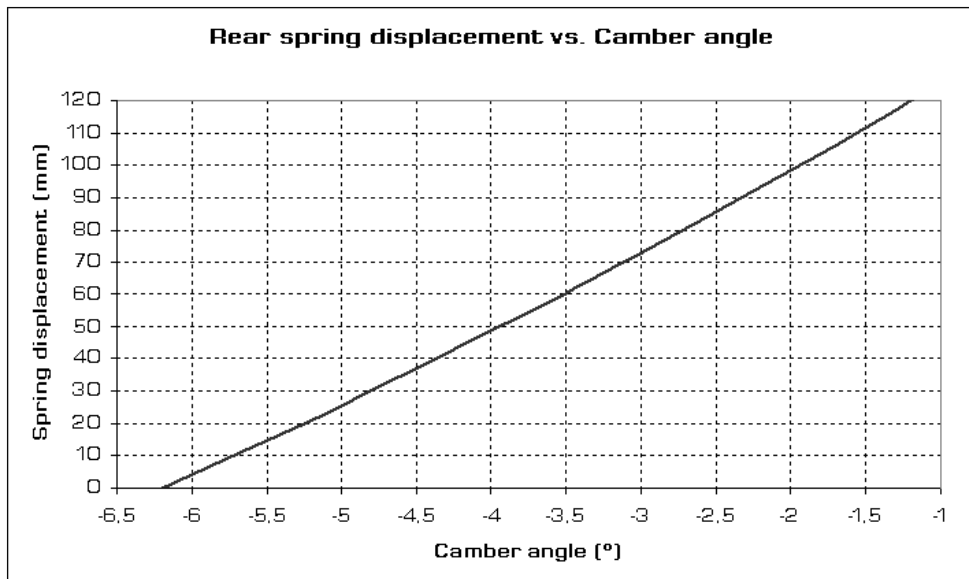
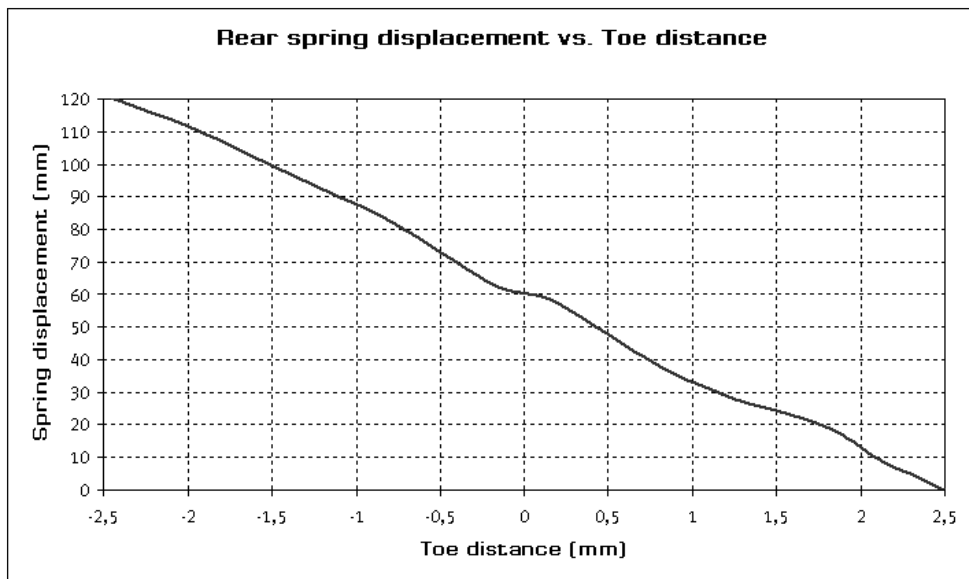

4.8 Brakes

To set-up the brakes, the following pumps can be used in both axles:

Master cylinder	Push Rod	Remarks
AP 15 mm	PRT 110	
AP 15.9 mm	PRT 110	
AP 16.8 mm	PRT 110	
AP 17.8 mm	PRT 110	
AP 19,1 mm	PRT 110	Car delivery front
AP 20,6 mm	PRT 110	
AP 22,2 mm	PRT 110	Car delivery rear
AP 23,8 mm	PRT 110	

Notes:

- It is not advisable to use more than two pump diameters difference between front and rear.
- If the master cylinders are replaced, take care on the correct installation and functioning of the brake balance bar. The following link shows how to assembly correctly:

tiltonracing.com/wp-content/uploads/2013/07/98-1250-600-Series-Balance-Bars.pdf

On the dashboard screen it is shown the front/rear pressure and the balance percentage. The recommended percentage is 60% front as in car delivery. The brake balance channel appearing on the display has been calculated using the following formula:

$$BRK_BALANCE = \frac{P_BRK_FRONT}{P_BRK_FRONT + P_BRK_REAR} * 100$$

To adjust the brake balance it is recommended to set first the rear brake proportioning valve on position 7 (lever backwards), where it is fully open, and to ensure that the hand brake is not locked. After that, set the desired balance turning the yellow wheel on the main console. Remember not to press the brake pedal while turning the wheel.



The different positions and settings for each position of the proportioning valve can be seen on the next pictures:

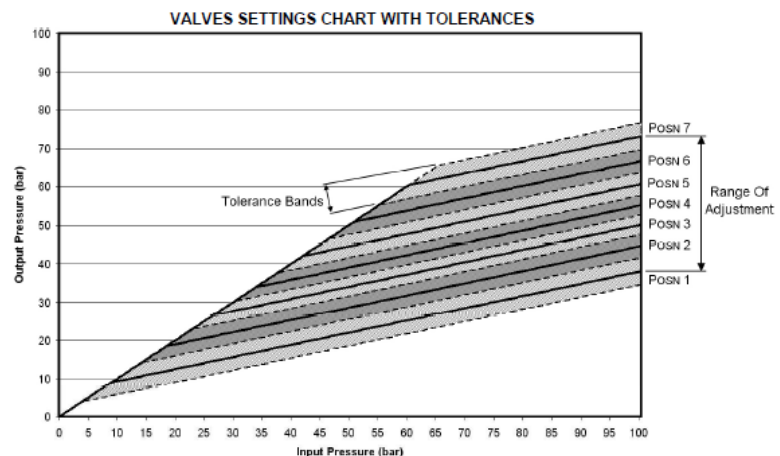
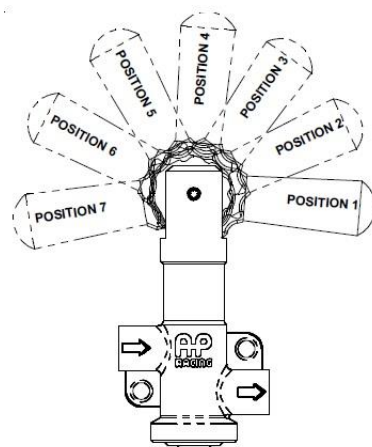

4.9 Aerodynamics

It is strongly recommended checking periodically that all bodyworks and their fixations are in good conditions.

Rear wing:

- The rear wing has extensive regulation. Zero is the standard setting for the car.
- Wing angle -5° has considerable influence on the rear down force.
- Wing angle -10° has big influence on the rear down force as well as in drag.
- Lateral plates are individually adjustable.

Front splitter:

- Check periodically the fixations. It has to be in good conditions.
- Check the front splitter angle that has to be at 0° when pitch is 0° .

Pitch:

- Measure the pitch angle on the body shell over the door sill.

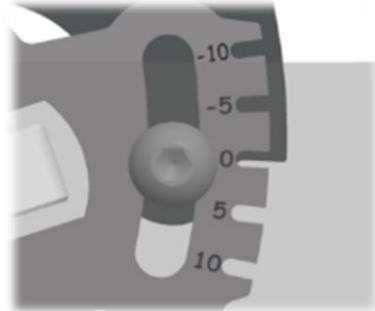
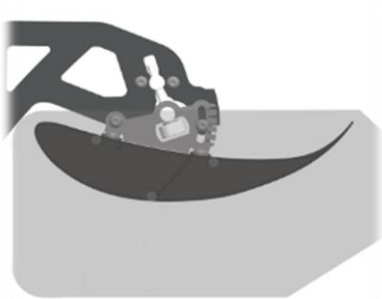

4.10 Driving position

On the following chapter how to adjust the driving position is explained.

Seat
FIA Homologated 8855–1999 OMP driver seat
2 sizes available upon request: Standard and XL size



Belts and net
OMP window net meeting FIA Standards
6-points OMP safety belts to be used with HANS

Notes:

- Check the homologation label expiry date.
- Check always that the belts and the driver are well fixed.

Steering column
Height and length adjustable
3 steering column hubs different in length available: 100, 120 and 140 mm (car delivery)
AIM MXG display bracket adjustable in 2 positions: high and low (car delivery)

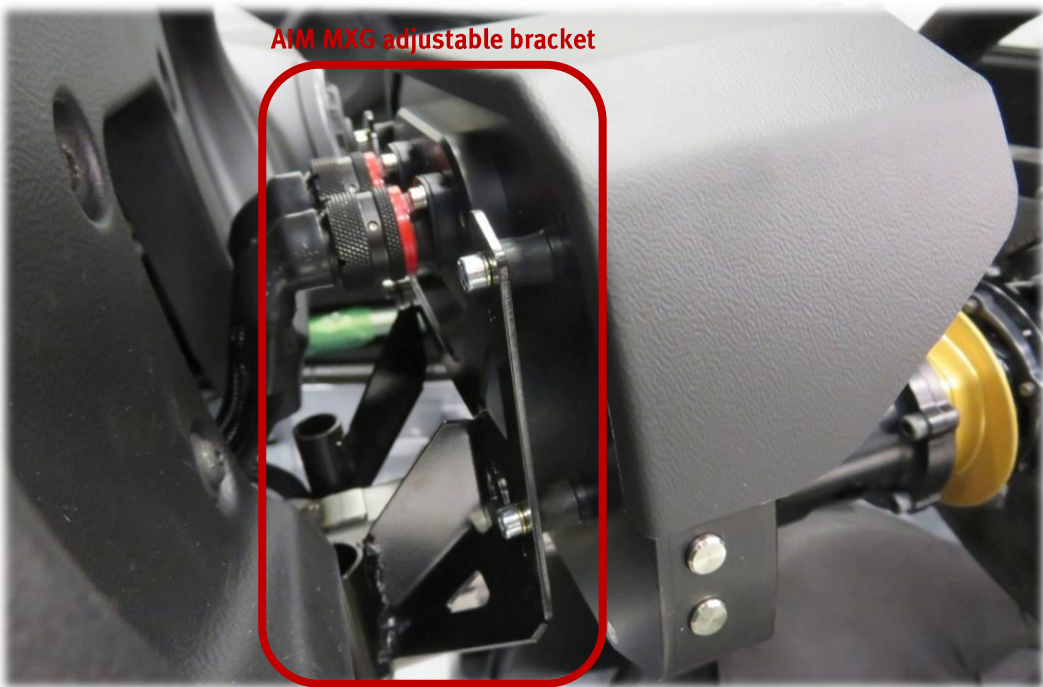
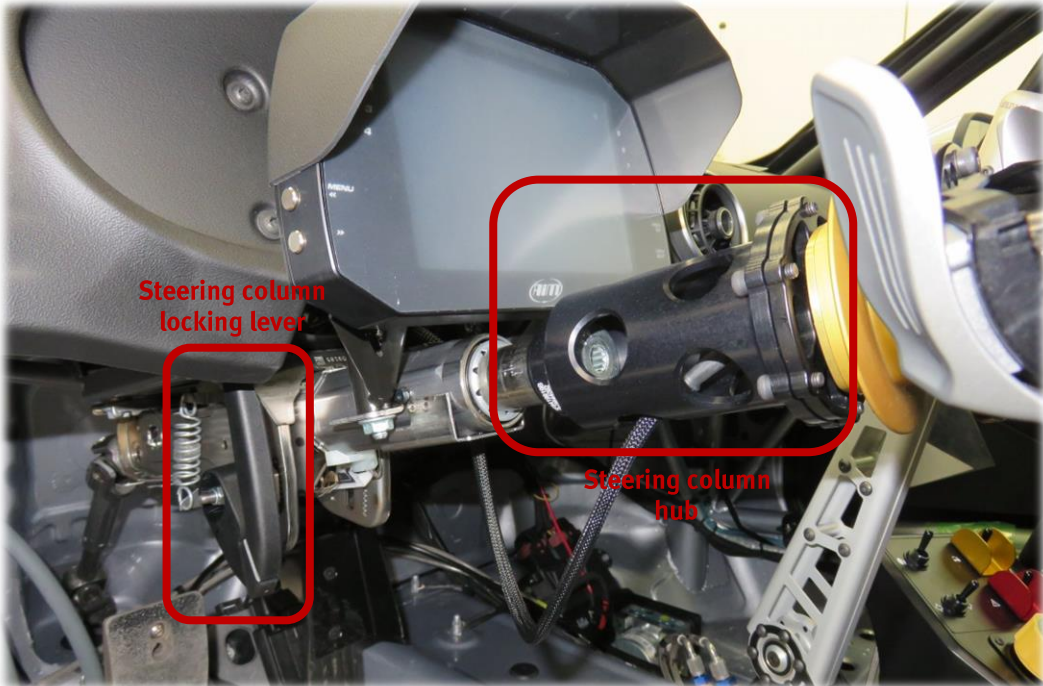

Pedal box

Length adjustable in 5 position (**car delivery - medium position**)

Tilton racing pedal assembly with brake balance bar

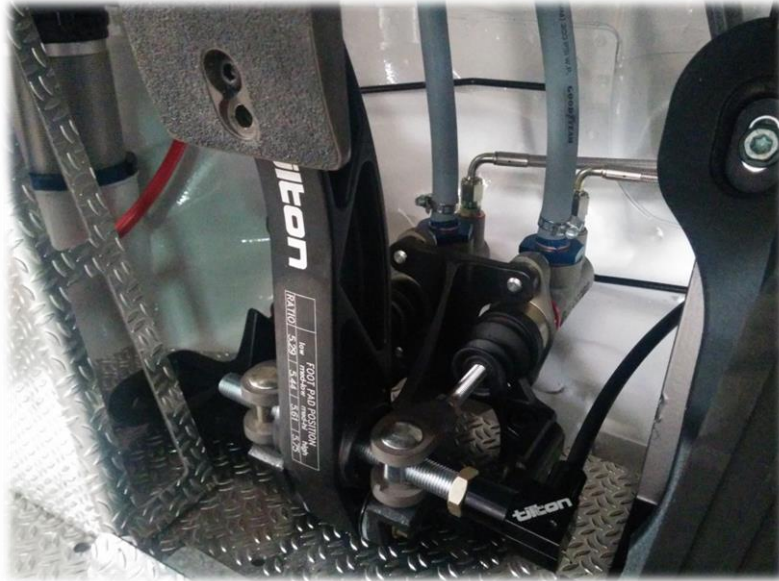

5 WORKSHOP MAINTENANCE

5.1 First roll-out

SEAT Sport checks all the cars in a roll-out before customer delivery. This roll-out consists in:

- 5 circuit laps.
- High speed in a long straight.
- Start rev limiter checking simulating a standing start.
- Speed limiter function checking.
- After the roll-out, SEAT Sport engineers check the data acquisition and all car functions.

Note:

- Although SEAT Sport does a roll-out, it is strongly recommended to carry out a suspension check before first customer roll-out and after the first practice. Pay special attention to sub-frame, power train, engine brackets, fixations, etc.

5.2 Check-list

After any rebuild or main job is recommend to carry out a check-list. It is possible to do it using the Live Measures view in RaceStudio3 and a lap top or directly using car's display.

		Check-list with engine stopped	OK
ENGINE	Oil level	On the dipstick mark / T_oil > 70°C	
	Coolant level	On the bottle mark	
BRAKES	Brake fluid	On the bottle mark	
		Steering wheel functions	OK
STEERING WHEEL	FCY		
	Cockpit fan		
	Display change		
	Safety brake signal		
	High beam / Flash		
	Wiper		
	Windscreen water		
	Rain light		
	Starter		
	Diff map change		
AIM Live		Check-list with engine at idle speed	OK
ENGINE	T_WATER	87°C / 92°C (thermostat cycle)	
	Fan	Active at 92°C	
	P_ENG_OIL (WT<25°C)	4 bar	
	P_ENG_OIL (WT>25°C)	2,5 bar	
	P_FUEL	> 4,1 bar	
	Battery voltage	> 13,5 volts	
	Boost pressure	0,3 bar @ 2500 rpm	
	Speed limiter	Check all speed limits	
GEARBOX	Tip		
	Gear display		
	Gearbox position		
DIFF	Diff pump		
	I_DIF_PUMP	> 0,7 A	
FUSEBOX	FLAG_FBX_1	0	
	FLAG_FBX_2	0	
	FLAG_FBX_3	0	
	FLAG_FBX_4	0	
	FLAG_FBX_5	0	

5.3 Body-shell and engine identification

V.I.N. (Vehicle Identification Number) is welded on the roll cage.



Engine number

CJX-XXXXXX



Engine seals: boost, distribution and oil sump

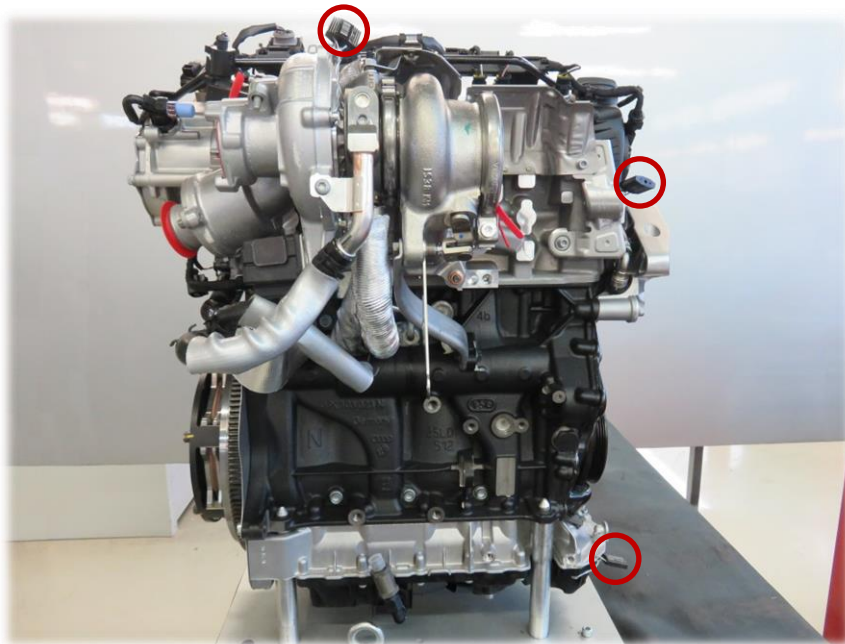

5.4 Fluids

Area	Fluid	Quantity
Engine	Castrol Edge 5W-30 LL 507	5,7 l
Gearbox	VW AG G052182A2	5,2 l
VAQ	VW AG G060175A2	0,5 l
Drive shaft	GKN grease	100 gr
Coolant	Castrol Radicool Si-OAT	5 l
	VW AG G13 10% add./90% dist. water	
Brake fluid	Castrol SRF	-
Fuel	102 RON	-
Windscreen	Free	-

Notes:

- Standard fuel minimum 98 RON from petrol stations may be used.
- Is recommended not to mix fuels, they could contaminate one from the other.
- Gearbox is delivered with correct oil level. It is not necessary any level control if there is no leakage.

5.5 Engine

Control routine before start to run:

- Check the oil level: with oil temperature up to 70°C, stop the engine and wait 2 minutes, then check the oil dipstick. The oil level must be at the top of the marked zone.
- Check the water level before start.
- With the engine running, check that there is not any oil, water or fuel leakage.
- Check the fan functionality. Operating range 92°C to 87°C.

Maintenance routine:

- Change the engine oil and oil filter at the indicated mileage.
- Engine spare parts must be from VW group or SEAT Sport original parts, detailed on the SEAT LCR TCR Spare Parts Catalogue.
- Use always the fluids detailed above, User Manual point 5.4.
- Clean and check the air filter at least once per event. At urban circuits, clean or replace it more frequently. It is recommended to have two or three air filters and replacing it during the weekend. Changing it is strongly recommended in case of rain.
- Check that the alternator belt is clean and that there are not small stones inside the Poly-V.
- Clean the radiator and intercooler panel often.
- If any doubt, contact SEAT Sport technical assistance department.
- Check that the seals are in good conditions, if a replacement is needed contact SEAT Sport.

Parts subject to frequent service:

Engine	Torque	Remarks
Oil drain plug	By hand	
Oil filter plastic cover	25 Nm	
Oil filter		Moisten the O-ring
Spark plug	28 Nm	Use only original parts

For detailed parts substitution information download the Workshop Manual from SEAT Sport website.

5.6 Air filter

Standard air filter cleaning procedure:

1. Remove the air filter from the car and plug opening to throttle body with a clean rag to stop any crud getting where it shouldn't.
2. Disassemble filter assembly by removing the four small screws at the bottom (intake side) of the outer-body and pull out the filter element.

3. Tap the filter gently to dislodge the larger debris that have collected, do not use compressed air as you could damage the paper elements.
4. Apply detergent to the filter. Squirt the fluid down the elements from the outside while holding the filter at an angle over a bucket. Don't re-distribute the detergent that's collected in the bucket through the filter again.
Once you covered the whole filter leave the filter to stand for ten minutes to allow the detergent to break down the old oil in the filter.
5. Using another bucket rinse filter with cold water until no more debris collects appear at the bottom of the bucket.
6. Pat your filter dry and place somewhere with good air flow and allow the filter to dry naturally. Do not use compressed air or place in a very warm area as this could damage the filter element.
7. Once you have applied two coats of oil along both sides of the filter pleats, hold the filter and ensure the filter is an even red colour.



8. Once it is evenly coated, leave it stand for 30 minutes. Carefully pat the excess off the filter with paper towels.
9. Rebuild your filter taking care that the screw holes match up and fit it back in the car.

Parts subject to frequent service:

Air filter	Torque	Remarks
Substitution	By hand	Be careful tightening the small bolts over plastic
Cleaning		Clean the cotton air filter following the procedure shown above. Do not use compressed air or high-pressure air to clean. Use only recommended oil for cotton filters.

Notes:

- The air filter type and measurements are identified on the Technical Form. It is not allowed any modification or change.
- A clean and properly oiled air filter is basic to ensure engine's life. It is strongly recommended to follow the cleaning procedure as well as the replacement frequency.
- After rain conditions use, it is strongly recommended the cleaning or replacement.

5.7 DSG gearbox

Control routine before start:

- Check that there is no oil leakage.
- Operating range 70°C to 135°C. Do not load the engine until the temperature is above 70°C.

Routine maintenance:

- Change the gearbox oil and filter at the indicated mileage.
- Oil filter and oil must be the recommended ones.

- All gearbox spares must be SEAT Sport original parts, detailed on the SEAT LCR TCR Spare Parts Catalogue.
- If there is no oil leakage it is not necessary any level control.
- Contact SEAT Sport and send it for service when the service mileage is reached.

How to change the gearbox oil:

- With the gearbox oil temperature below 50°C, the lever in position P, the vehicle on a level and the engine stopped, remove the oil drain plug and the overflow pipe located inside.
- Wait until all the oil runs out, more or less 5 litres, and screw the overflow pipe again (3Nm). Change now the gearbox oil filter.
- Fill 5,5 litres of new oil and hand-tight the oil drain plug. SEAT Sport recommends using the adapter for gearbox oil filling (VAS 6262A). If not fill it from the oil filter housing (slower).
- Start the engine. Release brake pedal and select each selector lever position for 3 seconds. Then go back to P. Do not switch off the engine.
- With the engine running at idle speed and the gearbox oil between 35 and 45°C, remove the oil drain plug again and let the surplus oil drain out. When it begins only to drip, install the oil drain plug with a new seal (45 Nm).

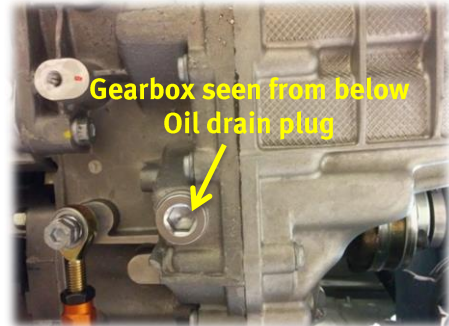

Note:

- If when doing the level after removing the oil drain plug no oil drains out: stop the engine, add 0,5 litres more and repeat the process from running the gearbox in all selector lever positions on.

How to adjust the selector lever:

- Unscrew the selector lever bolt (see picture).
- Put the lever in P position.
- Turn the gearbox selector lever backwards.
- Screw the selector lever bolt.

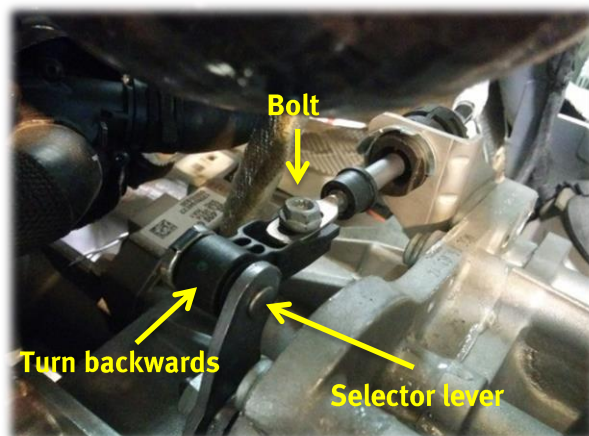

5.8 VAQ differential

The VAQ is a self-locking electro-hydraulic differential, with three different mappings that change the behaviour either for power or braking.

Routine maintenance:

- Change the VAQ oil at the indicated mileage.
- The oil must be the recommended one.
- All VAQ spares must be SEAT Sport original parts, detailed on the SEAT LCR TCR Spare Parts Catalogue.
- If there is no oil leakage it is not necessary any level control.
- Contact SEAT Sport and send it for service when the recommended service mileage is reached.

VAQ	Torque	Remarks
Oil level check cap	15 Nm	Change every time

How to change the VAQ oil:

- To replace the oil is recommended to disassemble the unit from the car.
- Open the level check cap, drain it and close it again.
- Measure the quantity and put in the same quantity.



- If it is done mounted on the car the last 100 ml are not possible to add from the cap (see the picture below). These last 100 ml must be added through the venting pipe on the engine bay.

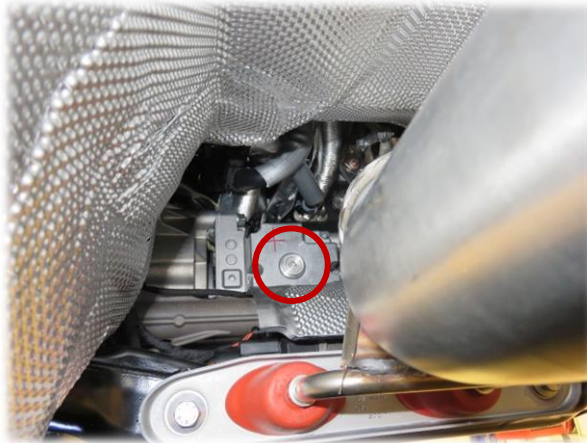

Notes:

- In case of disassembling the unit from the car, the unit must be positioned in vertical position, as it is shown in the picture above, to avoid oil leakages.

5.9 Fuel tank

The 100l FIA FT3 fuel tank is working with one unique fuel pump and a Venturi hoses system. The pump is controlled through a PWM fuel control module.

Refuelling tool:

The fuel tank is served with a FIA approved fast coupling plug. The socket is the necessary connecting-tool for refuelling the tank. This part is available on the Spare Parts Catalogue.



Refuelling process:

1. Prepare an external bottle with the desired amount of fuel. It is recommended using a ground cable on the bottle to avoid static electrical discharges.
2. Open the fuel tank cover, connect the refuelling hose with the socket to the fuel tank plug (#1 on the picture below) and the fuel will flow inside.
3. Set the fuel level display with the fuel amount inside the tank. This value will be shown also on the AIM MXG display. For more info about the fuel level display check point 3.5 above.

Fuel tank placed on the car:

1. Fuel tank refill plug
2. Fuel pump connector
3. Fuel level display
4. Battery supply

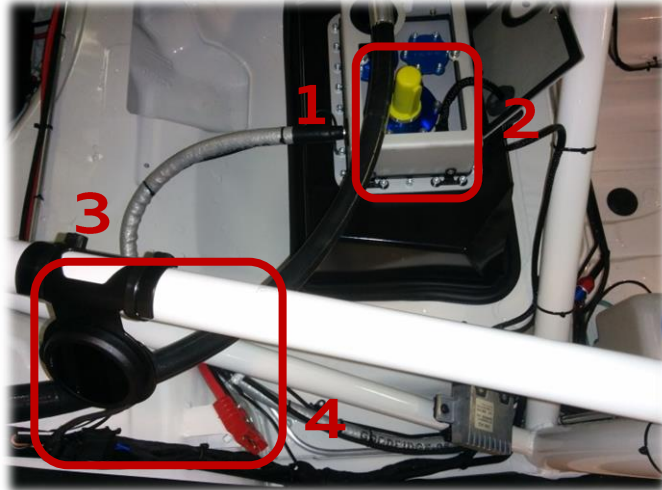

Fuel draining tools:

On the car there is a FIA fast coupling plug placed on the engine bay ready for safe draining use.



There are two tools available on the Spare Parts Catalogue. First, there is a contra-connector D-6 socket available to connect in the fuel line plug that opens the circuit for draining.



Secondly, SEAT Sport has developed a new electronic tool to activate the fuel tank pump both manually or with an automatic function.



Fuel draining process:

1. Connect the electronic tool on the fuel pump connector (#2 on the picture above), placed on the fuel tank, and the power supply on the auxiliary battery connector (#3).
2. Connect the fuel socked connector on the engine bay.
3. Switch on the electric tool in automatic or manual mode. If the automatic mode is selected the tool will stop the draining process when there is no more fuel inside the tank.

Flow fuel pump filter cleaning process:

1. Drain out the fuel tank completely.
2. Open the fuel tank right side cover (picture 1).
3. Raise a little bit the plate and disconnect the pipes and wirings.
4. Turn the fastening elements and pull up the pump from the reservoir (picture 2). Pull hard to disconnect the black hoses from the main pump. Remember to clip them hard again when mounting.
5. Remove the green mesh filter and clean it (picture 3).

In case you need to take out the reservoir, unclip the three green plastic brackets and pull-up the reservoir (picture 4).

Picture 1

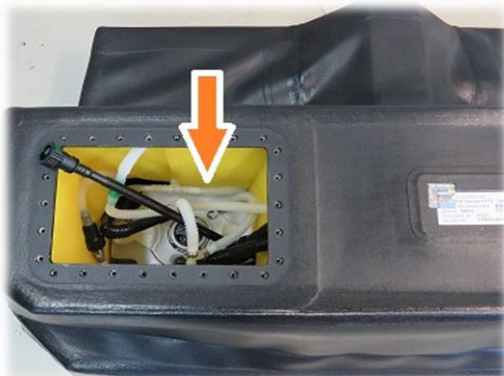

Picture 2

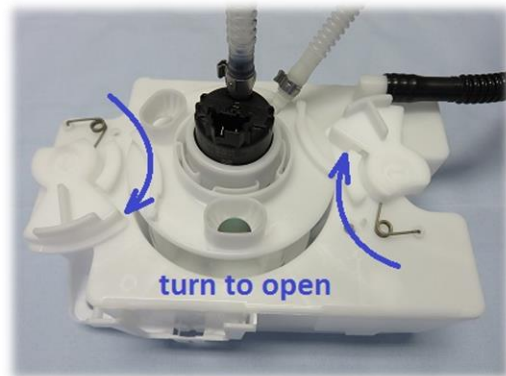

Picture 3

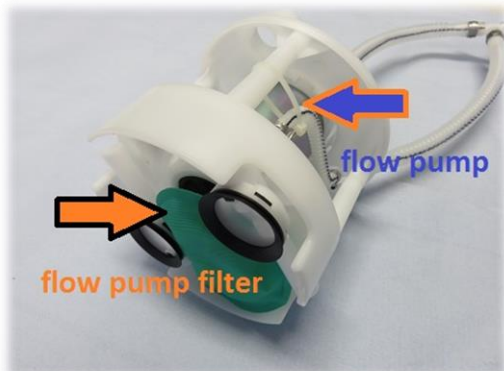

Picture 4

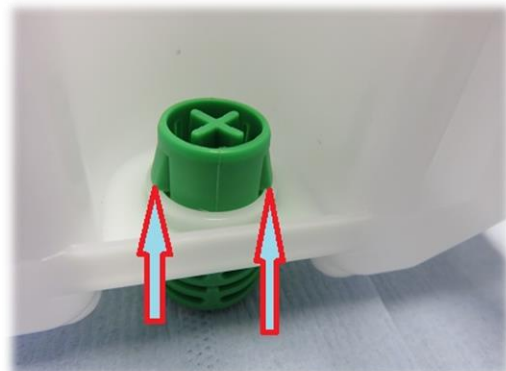

Engine fuel filter replacing process:

The engine fuel filter is placed inside the fuel cell fixed to a bracket by a tie-wrap, the fuel pipes are connected by fast couplings.

1. Drain out the fuel tank completely.
2. Open the right cover of the fuel tank.
3. Remove the fuel pump and the reservoir as explained above.
4. Cut the tie-wrap, disconnect the fuel pipes and take out the fuel filter.
5. Fix the new filter on the bracket, reconnect the fuel pipes, assemble the reservoir and close the fuel tank again.

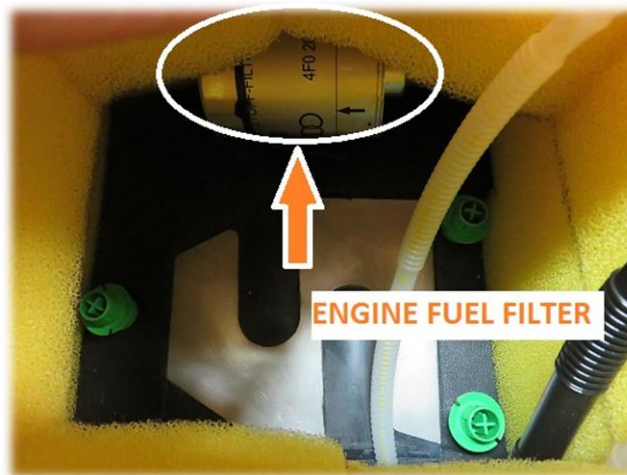

5.10 Airjacks

The SEAT LCR TCR is provided with a three airjack system. The connecting valve is placed on the rear right side, inside the road car refuelling cover.



Airlance and car plug dismounted view:



Airjack dismantled view:



Notes:

- Maximum air pressure is 30 bar.
- Inlet thread of the air lance is M16x1.5
- **IMPORTANT:** never work under a vehicle supported only by airjacks unless safety props are fitted.
- Jacks must be vertical during operation. Mounting brackets or clamps to be fitted to threaded section of body only. Do not loosen or remove the adaptors.
- Do not use petrol or paraffin for cleaning the airjacks as this will damage the rubber seals. Use an alcohol based cleaning fluid and silicone spray or silicone grease when internal lubrication is necessary.

6 PARTS MILEAGE

To check the car mileage, use the odometer available on the AIM MXG display. A reset can be done through the display menu or using RaceStudio3 on a laptop.

Engine	Inspection	Sprint race service	Sprint race change	Endurance race service	Endurance race change	Remark
Engine	-	7.000	12.000	9.000	14.000	SEAT Sport service
Spark plug	-	-	1.000	-	4.000	Use original parts only
Engine oil	-	-	1.000	-	4.000	Use recommended oil only
Oil filter	-	-	1.000	-	4.000	Use original parts only
Cotton air filter	Once per event	Once per event		Once per event	-	2 units rolling change adv.
Poly-V belt	Once per event	-	1.000	-	4.000	-

Transmission	Inspection	Sprint race service	Sprint race change	Endurance race service	Endurance race change	Remark
DSG gearbox	-	4.000	12.000	8.000	14.000	SEAT Sport Service - revisions over this mileage can be done under customer responsibility.
Gearbox oil	-	-	4.000	-	4.000	Use original parts only
Gearbox oil filter	-	-	4.000	-	4.000	Use original parts only
VAQ differential	-	4.000	12.000	8.000	14.000	SEAT Sport Service - revisions over this mileage can be done under customer responsibility.
Diff pump	-	-	4.000	-	4.000	Replace at this mileage
Diff oil	-	-	4.000	-	4.000	Use recommended oil only
Driveshaft	Once per event	4.000	12.000	8.000	14.000	-

Fuel tank	Inspection	Sprint race service	Sprint race change	Endurance race service	Endurance race change	Remark
Flow pump filter	1.000	-	8.000	-	8.000	First inspection at 150 km
Flow fuel pump	-	-	-	-	-	Control low fuel pressure data
Engine fuel filter	-	-	12.000	-	12.000	Use original parts only

Front axle	Inspection	Sprint race	Sprint race	Endurance race service	Endurance race change	Remark
------------	------------	-------------	-------------	------------------------	-----------------------	--------

		service	change			
Front dampers	-	4.000 / 1 year	12.000	4000 / 1 year	12.000	Bilstein service
Ball joints	Once per event	-	Once per year	-	8.000	Always check tolerance
Steering rod inner joint	Once per event	-	Once per year	-	8.000	Always check tolerance
Steering rack	-	-	15.000	-	15.000	-
Steering arm	Once per event	-	8.000	-	8.000	Change when noisy
Wheel hub	Once per event	-	10.000	-	10.000	Change when noisy
Front discs	Once per event	-	1.000	-	2.000	Change when cracked
Disc bells	-	-	Once per year	-	12.000	Check disc floats
Brake balance bar	Once per event	Once per year	-	Once per year	-	-
Wheel nuts	-	-	Once per year	-	Twice per year	-

Rear axle	Inspection	Sprint race service	Sprint race change	Endurance race service	Endurance race change	Remark
Rear dampers	-	4.000 / 1 year	12.000	4.000 / 1 year	12.000	Bilstein service
Ball joints	Once per event	-	Once per year	-	8.000	Always check tolerance
Wheel hub	Once per event	-	10.000	-	10.000	Change when noisy
Rear discs	-	-	3.000	-	4.000	Check wear
Wheel nuts	-	-	Once per year	-	Twice per year	-

Safety parts	Service	Change	Remark
Extinguisher	2 years	-	OMP Service
Seat	-	5 years	-
Safety belts	-	5 years	-
Fuel bladder	5 years	7 years	-
Battery	-	3 years	Check leakages

